



SINGA BEARINGS SOLUTIONS

SBS MINING BEARINGS

Experience the difference





SBS - SINGA BEARINGS SOLUTIONS



www.sbs-bearings.com



Table of contents

CATERPILLAR CAT D5	1	HITACHI EX1100	13
CATERPILLAR CAT D6		HITACHI EX1200	
CATERPILLAR CAT D7		HITACHI EX1800	14
CATERPILLAR CAT D8	2	HITACHI EX1900	15
D8 SERIES		HITACHI EX2500	16
CATERPILLAR CAT D10	3	HITACHI EX2600	17
CATERPILLAR CAT D11		HITACHI EX3500	
CATERPILLAR CAT 235/245		HITACHI EX3600	18
CATERPILLAR CAT 320/330/330GC/336GC		HITACHI EX5500	
CATERPILLAR CAT 6015	4	HITACHI EX5600	
CATERPILLAR CAT 6020		KOMATSU D40	19
CATERPILLAR CAT 6030		KOMATSU D41	
CATERPILLAR CAT 6040/TEREX RH170B	5	KOMATSU D50	
CATERPILLAR CAT 6060		KOMATSU D53	
CATERPILLAR CAT TH220, TH330,TH340, TH350		KOMATSU D58	20
CATERPILLAR CAT 410, 420, 430, 440, 450		KOMATSU D60	
CATERPILLAR CAT 517/527	6	KOMATSU D61	
CATERPILLAR CAT 525		KOMATSU D65	21
CATERPILLAR CAT 572		KOMATSU D68	
CATERPILLAR CAT 583/587/PL72/ PL83/PL87		KOMATSU D70	
CATERPILLAR CAT PM201/565		KOMATSU D85	22
CATERPILLAR CAT 14/16/18	7	KOMATSU D135	
CATERPILLAR CAT 5120/130/140		KOMATSU D150	
CATERPILLAR CAT 24		KOMATSU D155	23
CATERPILLAR CAT 630/640/650/660		KOMATSU D355	
CATERPILLAR CAT D35/44/550		KOMATSU D375	24
CATERPILLAR CAT 770	8	KOMATSU D455	
CATERPILLAR CAT 772/773/775		KOMATSU D460/465	
CATERPILLAR CAT 776		KOMATSU D475	25
CATERPILLAR CAT 777	9	KOMATSU D575	
CATERPILLAR CAT 784		KOMATSU PC220	
CATERPILLAR CAT 785		KOMATSU PC228	
CATERPILLAR CAT 789	10	KOMATSU PC240	
CATERPILLAR CAT 793		KOMATSU PC270	26
CATERPILLAR CAT 794/798 AC		KOMATSU PC300	
CATERPILLAR CAT MT4400D AC	11	KOMATSU PC350	
CATERPILLAR CAT 797		KOMATSU PC400	
CATERPILLAR CAT 834/844		KOMATSU PC450	27
CATERPILLAR CAT 850		KOMATSU PC550	
CATERPILLAR CAT 910/IT12/IT14	12	KOMATSU PC600	
CATERPILLAR CAT 920, 930, 950, 960, 970, IT20, IT30, IT60		KOMATSU PC650	28
CATERPILLAR CAT 963		KOMATSU PC700	
HITACHI UH261		KOMATSU PC710	29
HITACHI EX1000/UH501		KOMATSU PC750	

KOMATSU PC800	30	LIEBHERR R9250	46
KOMATSU PC850	31	LIEBHERR R9350	
KOMATSU PC1000	32	LIEBHERR R9400	
KOMATSU PC1100			
KOMATSU PC1250	33	TEF-MET®	47
KOMATSU PC1600		Wrapped composite dry sliding bearing, steel/PTFE, maintenance-free	
KOMATSU PC1800			
KOMATSU PC2000	34	POM-MET®	53
KOMATSU PC3000-6	35	Wrapped composite sliding bearing, steel/acetal resin (POM), lubrication pockets, low-maintenance	
KOMATSU PC4000			
KOMATSU PC4000-6		LUB-MET®	57
KOMATSU 330M	36	Solid bronze sliding bearing, solid lubricant, maintenance-free	
KOMATSU HD320			
KOMATSU HD325		BRO-MAS®	61
KOMATSU HD405	37	Solid turned bronze sliding bearing, heavy-maintenance	
KOMATSU HD460			
KOMATSU HD465	38	FER-MAS®	64
KOMATSU HD605	39	Turned steel sliding bearing, heavy-maintenance	
KOMATSU HD680			
KOMATSU HD780		FER-MET®	67
KOMATSU HD785	40	Wrapped steel bearing, inner and outer tension bushing, heavy-maintenance	
KOMATSU 830E/930E	41		
KOMATSU 960E		FER-MAN®246	70
KOMATSU HD985		Low maintenance impact-resistance steel sliding bearing with very high surface hardness	
KOMATSU HD1200	42		
KOMATSU HD1500		FER-MAN®259	70
KOMATSU HM300/350/400		Maintenance-free steel bushing, impact resistant, high breaking strength, able to absorb shock loadings	
KOMATSU WD600			
KOMATSU WD900		COM-KU®/D	74
KOMATSU WA150	43	Spherical plain bearing, stainless steel, with COM-KU®/D sliding layer, maintenance-free and corrosion-free	
KOMATSU WA200/250			
KOMATSU WA400/420			
KOMATSU WA430 WA450 WA470 WA480		BIV-MET®	77
KOMATSU WA500		Wrapped composite sliding bearing, steel/bronze, lubrication pockets, low-maintenance	
KOMATSU WA600	44		
KOMATSU WA700 WA800 WA900		SPHERICAL PLAIN BEARINGS & ROD ENDS	81
KOMATSU D66-S		Ball joint ends - spherical plain bearings, maintenance-free and heavy-maintenance	
KOMATSU BR580JG/BR380JG			
KOMATSU JV80/100/130	45		
KOMATSU WS23S			
LE TOURNEAU L2350			
LIEBHERR R954			
LIEBHERR R996			

	Parts Compatible With :				Model :
	CATERPILLAR®				D5 series
	Bearing Type	SBS PN	Genuine PN	Part Name	Application
	FER-MAS®	FSZ201-637639-si	4K3128	BUSHING	Ripper Cylinder - Trunnion
	FER-MAS®	FSZ218-506333-i	2582305 / 9P1779	BUSHING	Radiator Guard Main Frame

	Parts Compatible With :				Model :
	CATERPILLAR®				D6 series
	Bearing Type	SBS PN	Genuine PN	Part Name	Application
	FER-MAS®	FSZ201-637639-si	4K3128	BUSHING	Ripper Cylinder - Trunnion
	FER-MAS®	FSZ218-506333-i	2582305 / 9P1779	BUSHING	Radiator Guard Main Frame



	Parts Compatible With :				Model :
	CATERPILLAR®				D7 series
	Bearing Type	SBS PN	Genuine PN	Part Name	Application
	FER-MAS®	FSZ218-11412676-i	5J8118	BUSHING	Radiator Guard
	FER-MAS®	FSZ218-8910149-i	3J7189	BUSHING	Radiator Guard
	FER-MAS®	FSZ218-577030	2582308 / 6Y5812	BUSHING	Radiator Guard
	FER-MAS®	FSZ218-506333-i	2582305 / 9P1779	BUSHING	Radiator Guard Main Frame
	FER-MAS®	FSZ218-668145-si	1041844	BEARING-SLEEVE	Lift Cylinder Mounting
	FER-MAS®	FSZ201-769560-si	3G5999	BUSHING	Ripper Cylinder (Barrel/Rod End) Ripper Frame Hinge
	FER-MAS®	FSZ218-576538-i	3256023 / 6E1108	BEARING-SLEEVE	Blade Lift Cylinder (Barrel End)
	FER-MAS®	FSZ218-809055-s	1303139	BUSHING	Equalizer Bar
	FER-MAS®	FSZ218-769538-i	3J6484	BEARING-SLEEVE	Main Frame

SPB: Spherical Plain Bearings | FER-MAS®: Hardened Steel Bush | FER-MAN®: Hardened Manganese Steel | TEF-MET®: PTFE Coated Bush
 BRO-MAS®: High Strength Bronze Bush | BIV-MET®: Bimetal Steel/Bronze | COM-KU®/M: Fiberglass Composite

Disclaimer

All brand names, model names or marks are owned by their respective manufacturers. SBS – Singa Bearings Solutions Pte Ltd has no affiliation with the original equipment manufacturer. These terms are used for identification purposes only and are not intended to indicate affiliation with or approval by the OEM. All parts are manufactured by, for and warranted by SBS – Singa Bearings Solutions Pte Ltd and are not manufactured by, purchased from or warranted by the original equipment manufacturer.



		Parts Compatible With :			Model :	
		CATERPILLAR®			D8 series	
		Bearing Type	SBS PN	Genuine PN	Part Name	Application
		FER-MAS®	FSZ218-11412676-i	5J8118	BUSHING	Radiator Guard
		FER-MAS®	FSZ218-577030	2582308 / 6Y5812	BUSHING	Radiator Guard
		FER-MAS®	FSZ218-8910149-i	3J7189	BUSHING	Radiator Guard
		FER-MAS®	FSZ218-506333-i	2582305 / 9P1779	BUSHING	Radiator Guard Main Frame
		FER-MAS®	FSZ218-708244-i	3886576 / 8E6752	BEARING-SLEEVE	Blade Connector/Bracket (Push Arm)
		FER-MAS®	FSZ218-668145-si	1O41844	BEARING-SLEEVE	Lift Cylinder Mounting
		FER-MAS®	FSZ218-708259-i	3G9598	BUSHING	Push Arm Bracket (Blade)
		FER-MAS®	FSZ201-769560-si	3G5999	BUSHING	Ripper Lift/Tilt/Tip Cylinder (Barrel/Rod End)
		FER-MAS®	FSZ218-769538-i	3J6484	BEARING-SLEEVE	Ripper Tilt Cylinder (Barrel/Rod End)
		FER-MAS®	FSZ218-708344-i	1U2182	BEARING-SLEEVE	Blade Tilt Cylinder (Barrel/Rod End)
		FER-MAS®	FSZ218-576538-i	3256023 / 6E1108	BEARING-SLEEVE	Blade Lift Cylinder (Barrel End)
		FER-MAS®	FSZ218-809055-s	1303139	BUSHING	Equalizer Bar
SPB	GE259-7013086-si	7J3297	BEARING	Push Arm Bracket (Blade) Blade Tilt Cylinder (Rod End)		



		Parts Compatible With :			Model :	
		CATERPILLAR®			D9 series	
		Bearing Type	SBS PN	Genuine PN	Part Name	Application
		FER-MAS®	FSZ201-769560-si	3G5999	BUSHING	Ripper Tip Cylinder (Barrel/Rod End)
		FER-MAS®	FSZ218-769538-i	3J6484	BEARING-SLEEVE	Ripper Tilt Cylinder (Barrel/Rod End)
		FER-MAS®	FSZ218-708259-i	3G9598	BUSHING	Push Arm Bracket (Blade)
		FER-MAS®	FSZ218-708244-i	3886576 / 8E6752	BEARING-SLEEVE	Blade Connector/Bracket (Push Arm)
		FER-MAS®	FSZ218-708344-i	1U2182	BEARING-SLEEVE	Blade Tilt Cylinder (Barrel/Rod End)
SPB	GE259-7013086-si	7J3297	BEARING	Push Arm Bracket (Blade) Blade Tilt Cylinder (Rod End)		



SPB: Spherical Plain Bearings | FER-MAS®: Hardened Steel Bush | FER-MAN®: Hardened Manganese Steel | TEF-MET®: PTFE Coated Bush
 BRO-MAS®: High Strength Bronze Bush | BIV-MET®: Bimetal Steel/Bronze | COM-KU®/M: Fiberglass Composite



Disclaimer

All brand names, model names or marks are owned by their respective manufacturers. SBS – Singa Bearings Solutions Pte Ltd has no affiliation with the original equipment manufacturer. These terms are used for identification purposes only and are not intended to indicate affiliation with or approval by the OEM. All parts are manufactured by, for and warranted by SBS – Singa Bearings Solutions Pte Ltd and are not manufactured by, purchased from or warranted by the original equipment manufacturer.

	Parts Compatible With :				Model :
	CATERPILLAR®				D10 series
Dozer					
	Bearing Type	SBS PN	Genuine PN	Part Name	Application
	FER-MAS®	FSZ218-577030	2582308 / 6Y5812	BUSHING	Radiator Guard Main Frame
	FER-MAS®	FSZ218-769538-i	3J6484	BEARING-SLEEVE	Ripper Tilt Cylinder (Barrel/Rod End)
	SPB	GE259-9514983-si	1173006	BEARING	Blade Tilt Cylinder (Rod End) Push Arm Stabilizer

	Parts Compatible With :				Model :
	CATERPILLAR®				D11 series
Dozer					
	Bearing Type	SBS PN	Genuine PN	Part Name	Application
	FER-MAS®	FSZ218-577030	2582308 / 6Y5812	BUSHING	Main Frame Fender
	FER-MAS®	FSZ218-769538-i	3J6484	BEARING-SLEEVE	Blade Tilt Cylinder (Barrel/Rod End)
	SPB	GE259-10115989-si	6V3249	BEARING	Push Arm Stabilizer



	Parts Compatible With :				Model :
	CATERPILLAR®				235/245 series
Excavator					
	Bearing Type	SBS PN	Genuine PN	Part Name	Application
	SPB	GE259-114187119-si	9U9558 / 3G3521	BEARING	Boom Cylinder (Barrel /Rod End) Bucket Cylinder (Barrel End)



	Parts Compatible With :				Model :
	CATERPILLAR®				320/330/330GC/336GC series
Excavator					
	Bearing Type	SBS PN	Genuine PN	Part Name	Application
	FER-MAS®	FSZ201-809557-si	5047638	BEARING-SLEEVE	Stick/Bucket Cylinder (Barrel/Rod End)



SPB: Spherical Plain Bearings | FER-MAS®: Hardened Steel Bush | FER-MAN®: Hardened Manganese Steel | TEF-MET®: PTFE Coated Bush
 BRO-MAS®: High Strength Bronze Bush | BIV-MET®: Bimetal Steel/Bronze | COM-KU®/M: Fiberglass Composite

Disclaimer

All brand names, model names or marks are owned by their respective manufacturers. SBS – Singa Bearings Solutions Pte Ltd has no affiliation with the original equipment manufacturer. These terms are used for identification purposes only and are not intended to indicate affiliation with or approval by the OEM. All parts are manufactured by, for and warranted by SBS – Singa Bearings Solutions Pte Ltd and are not manufactured by, purchased from or warranted by the original equipment manufacturer.

	Parts Compatible With :				Model :
	CATERPILLAR®				6015 series
					Excavator
	Bearing Type	SBS PN	Genuine PN	Part Name	Application
	FER-MAN®	FNB259-150166123-s		BUSHING	Idler
	FER-MAS®	FSP214-150524-s		PIN	Idler



	Parts Compatible With :				Model :
	CATERPILLAR®				6020 series
					Excavator/Front Shovel
	Bearing Type	SBS PN	Genuine PN	Part Name	Application
	FER-MAS®	FSB210-170190165-s	4684111	BUSHING	Bucket Hinge
	FER-MAS®	FSB210-190215190-s	4365365	BUSHING	Bucket Hinge



	Parts Compatible With :				Model :
	CATERPILLAR®				6030 series
					Excavator/Front Shovel
	Bearing Type	SBS PN	Genuine PN	Part Name	Application
	FER-MAN®	FNB259-185205140-s	4658349	BUSHING	Idler
	FER-MAS®	FSP214-185640-s	-	PIN	Idler
	FER-MAS®	FSP214-85241	4658480	PIN	Tracklink
	FER-MAS®	FSZ206-85105106	4658485	BUSHING	Tracklink
	FER-MAS®	FSZ206-8510554	4658484	BUSHING	Tracklink



SPB: Spherical Plain Bearings | FER-MAS®: Hardened Steel Bush | FER-MAN®: Hardened Manganese Steel | TEF-MET®: PTFE Coated Bush
 BRO-MAS®: High Strength Bronze Bush | BIV-MET®: Bimetal Steel/Bronze | COM-KU®/M: Fiberglass Composite



Disclaimer

All brand names, model names or marks are owned by their respective manufacturers. SBS – Singa Bearings Solutions Pte Ltd has no affiliation with the original equipment manufacturer. These terms are used for identification purposes only and are not intended to indicate affiliation with or approval by the OEM. All parts are manufactured by, for and warranted by SBS – Singa Bearings Solutions Pte Ltd and are not manufactured by, purchased from or warranted by the original equipment manufacturer.

	Parts Compatible With :				Model :
	CATERPILLAR®				6040/TEREX RH170B series Excavator/Front Shovel
	Bearing Type	SBS PN	Genuine PN	Part Name	Application
	FER-MAS®	FSB243-9612048-s	-	BUSHING	Tracklink
	FER-MAS®	FSP214-96225-s	-	PIN	Tracklink
	FER-MAS®	FSP214-200730	-	PIN	Idler

	Parts Compatible With :				Model :
	CATERPILLAR®				6060 series Excavator/Front Shovel
	Bearing Type	SBS PN	Genuine PN	Part Name	Application
	BRO-MAS®	BSB108-12013585	-	BUSHING	Clam Cylinder (Rod End)
	BRO-MAS®	BSB108-180245130-s	4711979	BEARING-SLEEVE	Bucket Cylinder (Barrel End)
	BRO-MAS®	BSZ108-180195105-s	4711977	BEARING-SLEEVE	Bucket Cylinder (Rod End)
	SPB	GE259-120180108-s	-	BEARING	Clam Cylinder (Barrel End)



	Parts Compatible With :				Model :
	CATERPILLAR®				TH220, TH330, TH340, TH350 series Telehandler
	Bearing Type	SBS PN	Genuine PN	Part Name	Application
	COM-KU®/M	KMZ420-556855-si	1545404	BEARING	Front Axle & Steering Group



	Parts Compatible With :				Model :
	CATERPILLAR®				410, 420, 430, 440, 450 Series Backhoe Loader
	Bearing Type	SBS PN	Genuine PN	Part Name	Application
	COM-KU®/M	KMZ420-556855-si	1545404	BEARING	Front Axle & Steering Group



SPB: Spherical Plain Bearings | FER-MAS®: Hardened Steel Bush | FER-MAN®: Hardened Manganese Steel | TEF-MET®: PTFE Coated Bush
 BRO-MAS®: High Strength Bronze Bush | BIV-MET®: Bimetal Steel/Bronze | COM-KU®/M: Fiberglass Composite



Disclaimer



All brand names, model names or marks are owned by their respective manufacturers. SBS – Singa Bearings Solutions Pte Ltd has no affiliation with the original equipment manufacturer. These terms are used for identification purposes only and are not intended to indicate affiliation with or approval by the OEM. All parts are manufactured by, for and warranted by SBS – Singa Bearings Solutions Pte Ltd and are not manufactured by, purchased from or warranted by the original equipment manufacturer.

	Parts Compatible With :				Model :
	CATERPILLAR®				517/527 series Track Skidder
	Bearing Type	SBS PN	Genuine PN	Part Name	Application
	FER-MAS®	FSZ218-506333-i	2582305 / 9P1779	BUSHING	Grapple Frame
	SPB	GE259-10115989-si	6V3249	BUSHING	Grapple Frame

	Parts Compatible With :				Model :
	CATERPILLAR®				525 series Wheel Skidder
	Bearing Type	SBS PN	Genuine PN	Part Name	Application
	SPB	GE259-10115989-si	6V3249	BEARING	Grapple Frame

	Parts Compatible With :				Model :
	CATERPILLAR®				572 series Pipe Layer
	Bearing Type	SBS PN	Genuine PN	Part Name	Application
	FER-MAS®	FSZ218-577030	2582308 / 6Y5812	BUSHING	Radiator Guard
	FER-MAS®	FSZ218-809055-s	1303139	BUSHING	Equalizer Bar



	Parts Compatible With :				Model :
	CATERPILLAR®				583/587/PL72/PL83/PL87 series Pipe Layer
	Bearing Type	SBS PN	Genuine PN	Part Name	Application
	FER-MAS®	FSZ218-506333-i	2582305 / 9P1779	BUSHING	Radiator Guard Main Frame
	FER-MAS®	FSZ218-577030	2582308 / 6Y5812	BUSHING	Radiator Guard



	Parts Compatible With :				Model :
	CATERPILLAR®				PM201/565 series Cold Planner
	Bearing Type	SBS PN	Genuine PN	Part Name	Application
	FER-MAS®	FSP214-64168	2215305 / 7D1292	BALLSTUD	Steering Cylinder (Barrel/Rod End) Steering Linkage (Both End)



SPB: Spherical Plain Bearings | FER-MAS®: Hardened Steel Bush | FER-MAN®: Hardened Manganese Steel | TEF-MET®: PTFE Coated Bush
 BRO-MAS®: High Strength Bronze Bush | BIV-MET®: Bimetal Steel/Bronze | COM-KU®/M: Fiberglass Composite



Disclaimer



All brand names, model names or marks are owned by their respective manufacturers. SBS – Singa Bearings Solutions Pte Ltd has no affiliation with the original equipment manufacturer. These terms are used for identification purposes only and are not intended to indicate affiliation with or approval by the OEM. All parts are manufactured by, for and warranted by SBS – Singa Bearings Solutions Pte Ltd and are not manufactured by, purchased from or warranted by the original equipment manufacturer.

	Parts Compatible With :				Model :
	CATERPILLAR®				14/16/18 series
					Motor Grader
	Bearing Type	SBS PN	Genuine PN	Part Name	Application
	FER-MAS®	FSZ201-637639-si	4K3128	BUSHING	Ripper Cylinder - Trunnion
	FER-MAS®	FSZ218-708259-i	3G9598	BUSHING	Push Arm Bracket (Blade)
COM-KU®/M	KMZ420-506350-si	8X5021	BEARING-SLEEVE	Articulation Cylinder (Barrel End)	

	Parts Compatible With :				Model :
	CATERPILLAR®				120/130/140 series
					Motor Grader
	Bearing Type	SBS PN	Genuine PN	Part Name	Application
	COM-KU®/M	KMZ420-506350-si	8X5021	BEARING-SLEEVE	Blade Lift Group

	Parts Compatible With :				Model :
	CATERPILLAR®				24 series
					Motor Grader
	Bearing Type	SBS PN	Genuine PN	Part Name	Application
	FER-MAS®	FSP214-64168	2215305 / 7D1292	BALLSTUD	Steering Cylinder (Rod End) Steering Linkage (Both End)



	Parts Compatible With :				Model :
	CATERPILLAR®				630/640/650/660 series
					Wheel Scraper
	Bearing Type	SBS PN	Genuine PN	Part Name	Application
	FER-MAS®	FSZ218-11412676-i	5J8118	BUSHING	Draft Frame
	SPB	GE259-8213072-si	5J9451	BEARING (SELF ALIGNING)	Bowl Cylinder (Rod End)



	Parts Compatible With :				Model :
	CATERPILLAR®				D35/44/550
					Articulated Truck
	Bearing Type	SBS PN	Genuine PN	Part Name	Application
	SPB	GE259-10115989-si	6V3249	BEARING	



SPB: Spherical Plain Bearings | FER-MAS®: Hardened Steel Bush | FER-MAN®: Hardened Manganese Steel | TEF-MET®: PTFE Coated Bush
 BRO-MAS®: High Strength Bronze Bush | BIV-MET®: Bimetal Steel/Bronze | COM-KU®/M: Fiberglass Composite

Disclaimer

All brand names, model names or marks are owned by their respective manufacturers. SBS – Singa Bearings Solutions Pte Ltd has no affiliation with the original equipment manufacturer. These terms are used for identification purposes only and are not intended to indicate affiliation with or approval by the OEM. All parts are manufactured by, for and warranted by SBS – Singa Bearings Solutions Pte Ltd and are not manufactured by, purchased from or warranted by the original equipment manufacturer.

	Parts Compatible With :				Model :
	CATERPILLAR®				770 series
					Rigid-Frame Truck
	Bearing Type	SBS PN	Genuine PN	Part Name	Application
	FER-MAS®	FSP214-64194	3844562	BALLSTUD	Steering Cylinder (Barrel/Rod End) Steering Linkage
	SPB	GE259-8213072-si	5J9451	BEARING (SELF ALIGNING)	Front Suspension (Barrel End)



	Parts Compatible With :				Model :
	CATERPILLAR®				772/773/775 series
					Rigid-Frame Truck
	Bearing Type	SBS PN	Genuine PN	Part Name	Application
	FER-MAS®	FSP214-64194	3844562	BALLSTUD	Steering Cylinder (Barrel/Rod End) Steering Linkage
	SPB	GE259-7013086-si	7J3297	BEARING	Rear Suspension Cylinder (Barrel/Rod End)
	SPB	GE259-8213072-si	5J9451	BEARING (SELF ALIGNING)	Front Suspension (Barrel End)



	Parts Compatible With :				Model :
	CATERPILLAR®				776 series
					Wagon Tractor-Truck
	Bearing Type	SBS PN	Genuine PN	Part Name	Application
	SPB	GE259-7013086-si	7J3297	BEARING	Rear Axle Housing Upper Bracket (Rod)
	SPB	GE259-82158101-si	8J8906	BEARING- SPHERICAL	Rear Suspension (Barrel/Rod End)
	SPB	GE259-8213072-si	5J9451	BEARING (SELF ALIGNING)	Front Suspension (Barrel End)
	SPB	GE259-13514971-OR-si	9D2319	BEARING	Hoist Cylinder (Barrel/Rod End)



SPB: Spherical Plain Bearings | FER-MAS®: Hardened Steel Bush | FER-MAN®: Hardened Manganese Steel | TEF-MET®: PTFE Coated Bush
 BRO-MAS®: High Strength Bronze Bush | BIV-MET®: Bimetal Steel/Bronze | COM-KU®/M: Fiberglass Composite

Disclaimer

All brand names, model names or marks are owned by their respective manufacturers. SBS – Singa Bearings Solutions Pte Ltd has no affiliation with the original equipment manufacturer. These terms are used for identification purposes only and are not intended to indicate affiliation with or approval by the OEM. All parts are manufactured by, for and warranted by SBS – Singa Bearings Solutions Pte Ltd and are not manufactured by, purchased from or warranted by the original equipment manufacturer.

	Parts Compatible With :				Model :
	CATERPILLAR®				777 series Rigid-Frame Truck
	Bearing Type	SBS PN	Genuine PN	Part Name	Application
	FER-MAS®	FSP214-64194	3844562	BALLSTUD	Steering Cylinder (Barrel/Rod End) Steering Linkage
	SPB	GE259-13514971-OR-si	9D2319	BEARING	Hoist Cylinder (Barrel/Rod End)
	SPB	GE259-7013086-si	7J3297	BEARING	Rear Axle Housing Upper Bracket (Rod)
	SPB	GE259-8213072-si	5J9451	BEARING (SELF ALIGNING)	Front Suspension (Barrel End) Hoist Cylinder (Barrel End)
	SPB	GE259-82158101-si	8J8906	BEARING- SPHERICAL	Rear Suspension (Barrel/Rod End)



	Parts Compatible With :				Model :
	CATERPILLAR®				784 series Tractor Truck
	Bearing Type	SBS PN	Genuine PN	Part Name	Application
	SPB	GE259-10011152-si	6V7959	BEARING AS	Steering Cylinder (Barrel/Rod End) Steering Linkage
	SPB	GE259-114187119-si	9U9558 / 3G3521	BEARING	Rear Suspension (Barrel/Rod End)
	SPB	GE259-8213072-si	5J9451	BEARING (SELF ALIGNING)	Front Suspension (Barrel End)



	Parts Compatible With :				Model :
	CATERPILLAR®				785 series Rigid-Frame Truck
	Bearing Type	SBS PN	Genuine PN	Part Name	Application
	SPB	GE259-10011152-si	6V7959	BEARING AS	Steering Cylinder (Barrel/Rod End) Steering Linkage
	SPB	GE259-10115989-si	6V3249	BEARING	Hoist Cylinder (Barrel End)
	SPB	GE259-114187119-si	9U9558 / 3G3521	BEARING	Rear Suspension (Barrel/Rod End)
	SPB	GE259-8213072-si	5J9451	BEARING (SELF ALIGNING)	Front Suspension (Barrel End)



SPB: Spherical Plain Bearings | FER-MAS®: Hardened Steel Bush | FER-MAN®: Hardened Manganese Steel | TEF-MET®: PTFE Coated Bush
 BRO-MAS®: High Strength Bronze Bush | BIV-MET®: Bimetal Steel/Bronze | COM-KU®/M: Fiberglass Composite

Disclaimer

All brand names, model names or marks are owned by their respective manufacturers. SBS – Singa Bearings Solutions Pte Ltd has no affiliation with the original equipment manufacturer. These terms are used for identification purposes only and are not intended to indicate affiliation with or approval by the OEM. All parts are manufactured by, for and warranted by SBS – Singa Bearings Solutions Pte Ltd and are not manufactured by, purchased from or warranted by the original equipment manufacturer.

	Parts Compatible With :				Model :
	CATERPILLAR®				789 series
					Rigid-Frame Truck
	Bearing Type	SBS PN	Genuine PN	Part Name	Application
	FER-MAS®	FSP214-100295-s	8X9620	BALLSTUD	Steering Cylinder (Barrel/Rod End) Steering Linkage
	SPB	GE259-10011152-si	6V7959	BEARING AS	Steering Cylinder (Barrel/Rod End) Steering Linkage
	SPB	GE259-10115989-si	6V3249	BEARING	Hoist Cylinder (Barrel End) Front Suspension (Barrel End)
SPB	GE259-127203127-si	1888697	BEARING	Rear Suspension (Barrel/Rod End)	



	Parts Compatible With :				Model :
	CATERPILLAR®				793 series
					Rigid-Frame Truck
	Bearing Type	SBS PN	Genuine PN	Part Name	Application
	FER-MAS®	FSP214-100295-s	8X9620	BALLSTUD	Steering Cylinder (Barrel/Rod End) Steering Linkage
	SPB	GE259-10011152-si	6V7959	BEARING AS	Steering Cylinder (Barrel End) Steering Linkage
	SPB	GE259-114177100-si	6Y9379	BEARING	Hoist Cylinder (Barrel/Rod End)
	SPB	GE259-14021090-sa	6Y9380	BEARING	Hoist Cylinder (Rod End)
	SPB	GE259-14021090-sa	6Y9380	BEARING	Hoist Cylinder (Rod End)
	SPB	GE259-127203127-si	1888697	BEARING	Rear Suspension (Barrel/Rod End)
SPB	GE259-10115989-si	6V3249	BEARING	Front Suspension (Barrel End)	



	Parts Compatible With :				Model :
	CATERPILLAR®				794/798 AC
					Rigid-Frame Truck
	Bearing Type	SBS PN	Genuine PN	Part Name	Application
	SPB	GE259-10115989-si	6V3249	BEARING	Frame Link Rear Axle Housing Mounting
SPB	GE259-114177100-si	6Y9379	BEARING	Hoist Cylinder (Barrel/Rod End)	



SPB: Spherical Plain Bearings | FER-MAS®: Hardened Steel Bush | FER-MAN®: Hardened Manganese Steel | TEF-MET®: PTFE Coated Bush
 BRO-MAS®: High Strength Bronze Bush | BIV-MET®: Bimetal Steel/Bronze | COM-KU®/M: Fiberglass Composite



Disclaimer

All brand names, model names or marks are owned by their respective manufacturers. SBS – Singa Bearings Solutions Pte Ltd has no affiliation with the original equipment manufacturer. These terms are used for identification purposes only and are not intended to indicate affiliation with or approval by the OEM. All parts are manufactured by, for and warranted by SBS – Singa Bearings Solutions Pte Ltd and are not manufactured by, purchased from or warranted by the original equipment manufacturer.

	Parts Compatible With :				Model :
	CATERPILLAR®				MT440D AC
Rigid-Frame Truck					
	Bearing Type	SBS PN	Genuine PN	Part Name	Application
	SPB	GE259-10115989-si	6V3249	BEARING	Frame Link Steering Arm
	SPB	GE259-114177100-si	6Y9379	BEARING	Hoist Cylinder (Barrel/Rod End)

	Parts Compatible With :				Model :
	CATERPILLAR®				797 series
Rigid-Frame Truck					
	Bearing Type	SBS PN	Genuine PN	Part Name	Application
	SPB	GE259-10011152-si	6V7959	BEARING AS	Steering Linkage (Both End)



	Parts Compatible With :				Model :
	CATERPILLAR®				834/844 series
Wheel Dozer					
 	Bearing Type	SBS PN	Genuine PN	Part Name	Application
	FER-MAS®	FSZ218-708259-i	3G9598	BUSHING	Push Arm Bracket (Blade)
	FER-MAS®	FSZ218-708244-i	3886576 / 8E6752	BEARING-SLEEVE	Blade Connector/Bracket (Push Arm)
	FER-MAS®	FSZ218-708344-i	1U2182	BEARING-SLEEVE	Blade Tilt Cylinder (Barrel/Rod End)
	FER-MAS®	FSZ218-769538-i	3J6484	BEARING-SLEEVE	Ripper Tilt Cylinder (Barrel/Rod End)
SPB	GE259-7013086-si	7J3297	BEARING	Blade Tilt Cylinder (Rod End)	



	Parts Compatible With :				Model :
	CATERPILLAR®				850 series
Wheel Dozer					
	Bearing Type	SBS PN	Genuine PN	Part Name	Application
	FER-MAS®	FSZ218-769538-i	3J6484	BEARING-SLEEVE	Ripper Tilt Cylinder (Barrel/Rod End)



SPB: Spherical Plain Bearings | FER-MAS®: Hardened Steel Bush | FER-MAN®: Hardened Manganese Steel | TEF-MET®: PTFE Coated Bush
 BRO-MAS®: High Strength Bronze Bush | BIV-MET®: Bimetal Steel/Bronze | COM-KU®/M: Fiberglass Composite

Disclaimer



All brand names, model names or marks are owned by their respective manufacturers. SBS – Singa Bearings Solutions Pte Ltd has no affiliation with the original equipment manufacturer. These terms are used for identification purposes only and are not intended to indicate affiliation with or approval by the OEM. All parts are manufactured by, for and warranted by SBS – Singa Bearings Solutions Pte Ltd and are not manufactured by, purchased from or warranted by the original equipment manufacturer.

	Parts Compatible With :				Model :
	CATERPILLAR®				910/IT12/IT14 series
Wheel Loader / Integrated Toolcarrier					
	Bearing Type	SBS PN	Genuine PN	Part Name	Application
	SPB	GE259-647132-sia	6M8953	RACE-OUTER	Steering Cylinder (Barrel/Rod End)

	Parts Compatible With :				Model :
	CATERPILLAR®				920, 930, 950, 960, 970 series IT20, IT30, IT60 series
Wheel Loader / Integrated Toolcarrier					
	Bearing Type	SBS PN	Genuine PN	Part Name	Application
	FER-MAS®	FSZ201-768981-s	4V8674	BEARING-BUSHING	Arm Pivot Hinge
	FER-MAS®	FSZ201-89105110-s	3V2333	BEARING-SLEEVE	Arm Hinge (Main Frame)

	Parts Compatible With :				Model :
	CATERPILLAR®				963 series
Wheel Loader / Integrated Toolcarrier					
	Bearing Type	SBS PN	Genuine PN	Part Name	Application
	FER-MAS®	FSZ201-768981-s	4V8674	BEARING-BUSHING	Lift Cylinder (Barrel End)



	Parts Compatible With :				Model :
	HITACHI®				UH261 Excavator
	Bearing Type	SBS PN	Genuine PN	Part Name	Application
	SPB	GE259-13020095110-s	0257017	BEARING	Boom Cylinder (Barrel End) Arm Cylinder (Rod End) Tilt Cylinder (Rod End)

	Parts Compatible With :				Model :
	HITACHI®				EX1000/UH501 Excavator
	Bearing Type	SBS PN	Genuine PN	Part Name	Application
	SPB	GE259-160240120-s	0859301 / 0257521	BEARING	Arm Cylinder (Rod End)
	FER-MAS®	FSZ201-15018080	4136526	BUSHING	Bucket Linkage

SPB: Spherical Plain Bearings | FER-MAS®: Hardened Steel Bush | FER-MAN®: Hardened Manganese Steel | TEF-MET®: PTFE Coated Bush
 BRO-MAS®: High Strength Bronze Bush | BIV-MET®: Bimetal Steel/Bronze | COM-KU®/M: Fiberglass Composite

Disclaimer

All brand names, model names or marks are owned by their respective manufacturers. SBS – Singa Bearings Solutions Pte Ltd has no affiliation with the original equipment manufacturer. These terms are used for identification purposes only and are not intended to indicate affiliation with or approval by the OEM. All parts are manufactured by, for and warranted by SBS – Singa Bearings Solutions Pte Ltd and are not manufactured by, purchased from or warranted by the original equipment manufacturer.

	Parts Compatible With :				Model :
	HITACHI®				EX1100
					Excavator
	Bearing Type	SBS PN	Genuine PN	Part Name	Application
	SPB	GE259-160240120-s	0859301 / 0257521	BEARING	Boom Cylinder (Barrel/Rod End)
	SPB	GE259-13020095110-s	0257017	BEARING	Bucket Cylinder (Rod End)

	Parts Compatible With :				Model :
	HITACHI®				EX1200
					Excavator
     	Bearing Type	SBS PN	Genuine PN	Part Name	Application
	BRO-MAS®	BSZ108-160175165-s	4469243	BUSHING	Boom Cylinder (Rod End)
	FER-MAS®	FSZ201-160175165-s	4465581	BUSHING	Boom Cylinder (Rod End)
	FER-MAS®	FSZ210-150165179-s	4674502 / 0809302	BUSHING	Bucket Cylinder (Barrel End)
	FER-MAS®	FSZ210-160175179-s	4674504 / 0809305	BUSHING	Bucket Cylinder (Rod End)
	SPB	GE259-160240120-s	0859301 / 0257521	BEARING	Boom Cylinder (Barrel/Rod End)
	SPB	GE259-180275155-s	0336306	BEARING	Arm Cylinder (Barrel End)
	SPB	GE259-13020095110-s	0257017	BEARING	Bucket Cylinder (Rod End)
	TEF-MET®	TFZ 17040	4392642	BUSHING	Boom Cylinder (Barrel End) Bucket Cylinder (Barrel Inner)
	TEF-MET®	TFZ 20060	0317704	BUSHING	Arm Cylinder

SPB: Spherical Plain Bearings | FER-MAS®: Hardened Steel Bush | FER-MAN®: Hardened Manganese Steel | TEF-MET®: PTFE Coated Bush
 BRO-MAS®: High Strength Bronze Bush | BIV-MET®: Bimetal Steel/Bronze | COM-KU®/M: Fiberglass Composite

Disclaimer



All brand names, model names or marks are owned by their respective manufacturers. SBS – Singa Bearings Solutions Pte Ltd has no affiliation with the original equipment manufacturer. These terms are used for identification purposes only and are not intended to indicate affiliation with or approval by the OEM. All parts are manufactured by, for and warranted by SBS – Singa Bearings Solutions Pte Ltd and are not manufactured by, purchased from or warranted by the original equipment manufacturer.

	Parts Compatible With :				Model :
	HITACHI®				EX1800 Excavator
Bearing Type	SBS PN	Genuine PN	Part Name	Application	
    	FER-MAS®	FSA210-17032015-s	3092759	THRUST WASHER	Bucket Parts
	FER-MAS®	FSP220-150610-s	3092016	PIN	Bucket Parts
	FER-MAS®	FSP220-130530-s	8084168	PIN	Bucket Linkage Arm Parts
	FER-MAS®	FSZ201-11013080	4319916	BUSHING	Bucket Linkage Arm Parts
	FER-MAS®	FSZ201-13015583	4202256	BUSHING	Bucket Linkage
	FER-MAS®	FSZ201-15018080	4136526	BUSHING	Bucket Linkage
	FER-MAS®	FSZ201-11013085-s	3041951	BUSHING	Arm Linkage
	FER-MAS®	FSZ201-150180120-s	4290514	BUSHING	Arm/Bucket Linkage
	FER-MAS®	FSZ201-15018095-s	4454646	BUSHING	Arm/Bucket Linkage
	SPB	GE259-160240120-s	0859301 / 0257521	BEARING	Bucket Cylinder (Barrel/Rod End)
	SPB	GE259-180275155-s	0336306	BEARING	Arm Cylinder (Barrel End) Boom Cylinder (Barrel End) Bucket Cylinder (Rod/Barrel End)
	SPB	GE259-13020095110-s	0257017	BEARING	Bucket Cylinder (Rod End)
	TEF-MET®	TFZ 17040	4392642	BUSHING	Bucket Cylinder (Barrel Inner) Arm Cylinder (Barrel Inner)
	TEF-MET®	TFZ 20060	0317704	BUSHING	Boom Cylinder (Barrel End) Level Cylinder (Barrel Inner)

SPB: Spherical Plain Bearings | FER-MAS®: Hardened Steel Bush | FER-MAN®: Hardened Manganese Steel | TEF-MET®: PTFE Coated Bush
 BRO-MAS®: High Strength Bronze Bush | BIV-MET®: Bimetal Steel/Bronze | COM-KU®/M: Fiberglass Composite

Disclaimer

All brand names, model names or marks are owned by their respective manufacturers. SBS – Singa Bearings Solutions Pte Ltd has no affiliation with the original equipment manufacturer. These terms are used for identification purposes only and are not intended to indicate affiliation with or approval by the OEM. All parts are manufactured by, for and warranted by SBS – Singa Bearings Solutions Pte Ltd and are not manufactured by, purchased from or warranted by the original equipment manufacturer.

	Parts Compatible With :				Model :
	HITACHI®				EX1900 Excavator
Bearing Type	SBS PN	Genuine PN	Part Name	Application	
     	BRO-MAS®	BSZ108-180200170-s	0834305	BUSHING	Boom Cylinder (Rod End) Level Cylinder (Rod End)
	FER-MAS®	FSA210-17032015-s	3092759	THRUST WASHER	Bucket Parts
	FER-MAS®	FSP220-150610-s	3092016	PIN	Bucket Parts
	FER-MAS®	FSP220-130530-s	8084168	PIN	Bucket Linkage Arm Parts
	FER-MAS®	FSZ201-11013080	4319916	BUSHING	Bucket Linkage Arm Parts
	FER-MAS®	FSZ201-15018080	4136526	BUSHING	Bucket Linkage
	FER-MAS®	FSZ201-13015583	4202256	BUSHING	Bucket Linkage
	FER-MAS®	FSZ201-11013085-s	3041951	BUSHING	Arm Linkage
	FER-MAS®	FSZ201-150180120-s	4290514	BUSHING	Arm/Bucket Linkage
	FER-MAS®	FSZ201-15018095-s	4454646	BUSHING	Arm/Bucket Linkage
	FER-MAS®	FSZ210-150165120-s	4674501 / 0834705	BUSHING	Bucket Cylinder (Rod End)
	FER-MAS®	FSZ210-180200170-s	0834506 / 0834505	BUSHING	Arm Cylinder (Rod End)
	SPB	GE259-13020095110-s	0257017	BEARING	Bucket Cylinder (Rod End)
	SPB	GE259-160240120-s	0859301 / 0257521	BEARING	Bucket Cylinder (Barrel/Rod End)
	SPB	GE259-180275155-s	0336306	BEARING	Arm Cylinder (Barrel End) Boom Cylinder (Barrel End) Bucket Cylinder (Rod/Barrel End)
	TEF-MET®	TFZ 17040	4392642	BUSHING	Bucket Cylinder (Barrel Inner) Arm Cylinder (Barrel Inner)
TEF-MET®	TFZ 20060	0317704	BUSHING	Boom Cylinder (Barrel End) Level Cylinder (Barrel Inner)	

SPB: Spherical Plain Bearings | FER-MAS®: Hardened Steel Bush | FER-MAN®: Hardened Manganese Steel | TEF-MET®: PTFE Coated Bush
 BRO-MAS®: High Strength Bronze Bush | BIV-MET®: Bimetal Steel/Bronze | COM-KU®/M: Fiberglass Composite

Disclaimer



All brand names, model names or marks are owned by their respective manufacturers. SBS – Singa Bearings Solutions Pte Ltd has no affiliation with the original equipment manufacturer. These terms are used for identification purposes only and are not intended to indicate affiliation with or approval by the OEM. All parts are manufactured by, for and warranted by SBS – Singa Bearings Solutions Pte Ltd and are not manufactured by, purchased from or warranted by the original equipment manufacturer.



	Parts Compatible With :				Model :
	HITACHI®				EX2500
					Excavator
Bearing Type	SBS PN	Genuine PN	Part Name	Application	
	BRO-MAS® BSB108-185205152-s	3069959	BUSHING	Front Idler	
	BRO-MAS® BSZ108-200220200-s	4379184	BUSHING	Boom Cylinder (Rod End)	
	FER-MAS® FSP214-75304	4339255 / 4452423	PIN	Tracklink	
	FER-MAS® FSZ201-160185150	4392649	BUSHING	Bucket Cylinder (Rod End)	
	FER-MAS® FSZ210-160185160-s	4392649	BUSHING	Bucket Cylinder (Rod End)	
	FER-MAS® FSZ201-200220200	4392648	BUSHING	Arm Cylinder (Rod End)	
	SPB GE259-160240120-s	0859301 / 0257521	BEARING	Bucket Cylinder (Barrel/Rod End)	
	SPB GE259-180275155-s	0336306	BEARING	Arm Cylinder (Barrel End) Bucket Cylinder (Rod/Barrel End)	
	SPB GE259-200325200-s	0317321	BEARING	Boom Cylinder (Barrel End) Level Cylinder (Barrel End)	
	TEF-MET® TFZ 17040	4392642	BUSHING	Bucket Cylinder (Barrel Inner)	
	TEF-MET® TFZ 20060	0317704	BUSHING	Arm Cylinder (Barrel End)	
	TEF-MET® TFZ 23060	4392641	BUSHING	Boom Cylinder (Barrel Inner) Level Cylinder (Barrel Inner)	

SPB: Spherical Plain Bearings | FER-MAS®: Hardened Steel Bush | FER-MAN®: Hardened Manganese Steel | TEF-MET®: PTFE Coated Bush
 BRO-MAS®: High Strength Bronze Bush | BIV-MET®: Bimetal Steel/Bronze | COM-KU®/M: Fiberglass Composite

Disclaimer

All brand names, model names or marks are owned by their respective manufacturers. SBS – Singa Bearings Solutions Pte Ltd has no affiliation with the original equipment manufacturer. These terms are used for identification purposes only and are not intended to indicate affiliation with or approval by the OEM. All parts are manufactured by, for and warranted by SBS – Singa Bearings Solutions Pte Ltd and are not manufactured by, purchased from or warranted by the original equipment manufacturer.



	Parts Compatible With :				Model :
	HITACHI®				EX2600
					Excavator
	Bearing Type	SBS PN	Genuine PN	Part Name	Application
	BRO-MAS®	BSB108-185205152-s	3069959	BUSHING	Front Idler
	BRO-MAS®	BSZ108-200220200-s	4379184	BUSHING	Boom Cylinder (Rod End)
	FER-MAS®	FSP214-75304	4339255 / 4452423	PIN	Tracklink
	FER-MAS®	FSZ210-160185150	4392649	BUSHING	Bucket Cylinder (Rod End)
	FER-MAS®	FSZ201-200220200	4392648	BUSHING	Arm Cylinder (Rod End)
	SPB	GE259-160240120-s	0859301 / 0257521	BEARING	Bucket Cylinder (Barrel/Rod End)
	SPB	GE259-180275155-s	0336306	BEARING	Arm Cylinder (Barrel End) Bucket Cylinder (Rod/Barrel End)
	SPB	GE259-200325200-s	0317321	BEARING	Boom Cylinder (Barrel End) Level Cylinder (Barrel End)
	TEF-MET®	TFZ 17040	4392642	BUSHING	Bucket Cylinder (Barrel Inner)
	TEF-MET®	TFZ 20060	0317704	BUSHING	Arm Cylinder (Barrel End)
	TEF-MET®	TFZ 23060	4392641	BUSHING	Boom Cylinder (Barrel Inner) Level Cylinder (Barrel Inner)



	Parts Compatible With :				Model :
	HITACHI®				EX3500
					Excavator
	Bearing Type	SBS PN	Genuine PN	Part Name	Application
	FER-MAS®	FSP214-85364	4184357	PIN	Tracklink
	FER-MAS®	FSZ201-11013080	4319916	BUSHING	Bucket Linkage Arm Parts
	FER-MAS®	FSZ201-11013085-s	3041951	BUSHING	Arm Linkage
	TEF-MET®	TFZ 20060	0317704	BUSHING	Bucket Cylinder (Barrel End)
	SPB	GE259-13020095110-s	0257017	BEARING	Bucket Cylinder (Rod End)
	SPB	GE259-200325200-s	0317321	BEARING	Arm Cylinder (Barrel/Rod End) Bucket Cylinder (Rod End)
	SPB	GE259-230360210-s	0317228	BEARING	Boom Cylinder (Barrel/Rod End) Level Cylinder (Barrel End)



SPB: Spherical Plain Bearings | FER-MAS®: Hardened Steel Bush | FER-MAN®: Hardened Manganese Steel | TEF-MET®: PTFE Coated Bush
 BRO-MAS®: High Strength Bronze Bush | BIV-MET®: Bimetal Steel/Bronze | COM-KU®/M: Fiberglass Composite

Disclaimer

All brand names, model names or marks are owned by their respective manufacturers. SBS – Singa Bearings Solutions Pte Ltd has no affiliation with the original equipment manufacturer. These terms are used for identification purposes only and are not intended to indicate affiliation with or approval by the OEM. All parts are manufactured by, for and warranted by SBS – Singa Bearings Solutions Pte Ltd and are not manufactured by, purchased from or warranted by the original equipment manufacturer.

	Parts Compatible With :				Model :
	HITACHI®				EX3600
					Excavator
	Bearing Type	SBS PN	Genuine PN	Part Name	Application
	FER-MAS®	FSP214-85364	4184357	PIN	Tracklink
	FER-MAS®	FSZ201-200220200	4392648	BUSHING	Arm Cylinder (Rod End)
	SPB	GE259-200325200-s	0317321	BEARING	Arm Cylinder (Barrel/Rod End) Bucket Cylinder (Rod End)
	SPB	GE259-230360210-s	0317228	BEARING	Boom Cylinder (Barrel/Rod End) Level Cylinder (Barrel End)
	TEF-MET®	TFZ 20060	0317704	BUSHING	Bucket Cylinder (Barrel End)



	Parts Compatible With :				Model :
	HITACHI®				EX5500
					Excavator
	Bearing Type	SBS PN	Genuine PN	Part Name	Application
	SPB	GE259-230360210-s	0317228	BEARING	Arm Cylinder (Barrel End) Bucket Cylinder (Barrel/Rod End)
	SPB	GE259-200325200-s	0317321	BEARING	Bucket Cylinder (Barrel End)
TEF-MET®	TFZ 23060	4392641	BUSHING	Bucket Cylinder (Barrel Inner)	



	Parts Compatible With :				Model :
	HITACHI®				EX5600
					Excavator
	Bearing Type	SBS PN	Genuine PN	Part Name	Application
	SPB	GE259-230360210-s	0317228	BEARING	Arm Cylinder (Barrel End) Bucket Cylinder (Barrel/Rod End)
	SPB	GE259-200325200-s	0317321	BEARING	Bucket Cylinder (Barrel End)
TEF-MET®	TFZ 23060	4392641	BUSHING	Bucket Cylinder (Barrel Inner)	



SPB: Spherical Plain Bearings | FER-MAS®: Hardened Steel Bush | FER-MAN®: Hardened Manganese Steel | TEF-MET®: PTFE Coated Bush
 BRO-MAS®: High Strength Bronze Bush | BIV-MET®: Bimetal Steel/Bronze | COM-KU®/M: Fiberglass Composite



Disclaimer

All brand names, model names or marks are owned by their respective manufacturers. SBS – Singa Bearings Solutions Pte Ltd has no affiliation with the original equipment manufacturer. These terms are used for identification purposes only and are not intended to indicate affiliation with or approval by the OEM. All parts are manufactured by, for and warranted by SBS – Singa Bearings Solutions Pte Ltd and are not manufactured by, purchased from or warranted by the original equipment manufacturer.

	Parts Compatible With :				Model :
	KOMATSU®				D40
					Dozer
	Bearing Type	SBS PN	Genuine PN	Part Name	Application
	SPB	GE259-409064-s	0713704006	BUSHING	Blade Tilt/Angle Cylinder (Barrel/Rod End)

	Parts Compatible With :				Model :
	KOMATSU®				D41
					Dozer
	Bearing Type	SBS PN	Genuine PN	Part Name	Application
	SPB	GE259-409064-s	0713704006	BUSHING	Blade Tilt/Angle Cylinder (Barrel/Rod End)
	SPB	GE259-4510072-s	0713704507	BUSHING	Blade Link (Frame)



	Parts Compatible With :				Model :
	KOMATSU®				D50
					Dozer
	Bearing Type	SBS PN	Genuine PN	Part Name	Application
	SPB	GE259-5512590-s	0713705509	BUSHING	Blade Tilt Cylinder (Barrel End)
	SPB	GE259-4510072-s	0713704507	BUSHING	Blade Angle Cylinder (Barrel End)



	Parts Compatible With :				Model :
	KOMATSU®				D53
					Dozer
	Bearing Type	SBS PN	Genuine PN	Part Name	Application
	SPB	GE259-5512590-s	0713705509	BUSHING	Blade Tilt Cylinder (Barrel End)
	SPB	GE259-4510072-s	0713704507	BUSHING	Blade Angle Cylinder (Barrel End)



SPB: Spherical Plain Bearings | FER-MAS®: Hardened Steel Bush | FER-MAN®: Hardened Manganese Steel | TEF-MET®: PTFE Coated Bush
 BRO-MAS®: High Strength Bronze Bush | BIV-MET®: Bimetal Steel/Bronze | COM-KU®/M: Fiberglass Composite

Disclaimer

All brand names, model names or marks are owned by their respective manufacturers. SBS – Singa Bearings Solutions Pte Ltd has no affiliation with the original equipment manufacturer. These terms are used for identification purposes only and are not intended to indicate affiliation with or approval by the OEM. All parts are manufactured by, for and warranted by SBS – Singa Bearings Solutions Pte Ltd and are not manufactured by, purchased from or warranted by the original equipment manufacturer.

	Parts Compatible With :				Model :
	KOMATSU®				D58
					Dozer
	Bearing Type	SBS PN	Genuine PN	Part Name	Application
	SPB	GE259-5512590-s	0713705509	BUSHING	Blade Tilt Cylinder (Barrel End)
	SPB	GE259-4510072-s	0713704507	BUSHING	Blade Angle Cylinder (Barrel End)



	Parts Compatible With :				Model :
	KOMATSU®				D60
					Dozer
 	Bearing Type	SBS PN	Genuine PN	Part Name	Application
	FER-MAS®	FSP214-60296-s	14Z5031530	PIN	Equalizer Bar
	FER-MAS®	FSP214-70306-s	14X5078120 / 14Y5011240	PIN	Equalizer Bar
	FER-MAS®	FSZ201-7085145-s	14Y5011250	BUSHING	Equalizer Bar
	SPB	GE259-409064-s	0713704006	BUSHING	Blade Lift Cylinder (Barrel/Rod End)
	SPB	GE259-609041-s	14Y5011460	BUSHING	Equalizer Bar

	Parts Compatible With :				Model :
	KOMATSU®				D61
					Dozer
	Bearing Type	SBS PN	Genuine PN	Part Name	Application
	SPB	GE259-5011080-s	0713705008	BUSHING	Blade Tilt/Angle Cylinder (Barrel/Rod End)
	SPB	GE259-4510072-s	0713704507	BUSHING	Angle Cylinder (Rod End)



SPB: Spherical Plain Bearings | FER-MAS®: Hardened Steel Bush | FER-MAN®: Hardened Manganese Steel | TEF-MET®: PTFE Coated Bush
 BRO-MAS®: High Strength Bronze Bush | BIV-MET®: Bimetal Steel/Bronze | COM-KU®/M: Fiberglass Composite

Disclaimer

All brand names, model names or marks are owned by their respective manufacturers. SBS – Singa Bearings Solutions Pte Ltd has no affiliation with the original equipment manufacturer. These terms are used for identification purposes only and are not intended to indicate affiliation with or approval by the OEM. All parts are manufactured by, for and warranted by SBS – Singa Bearings Solutions Pte Ltd and are not manufactured by, purchased from or warranted by the original equipment manufacturer.

	Parts Compatible With :				Model :
	KOMATSU®				D65
					Dozer
	Bearing Type	SBS PN	Genuine PN	Part Name	Application
	FER-MAS®	FSP214-60296-s	14Z5031530	PIN	Equalizer Bar
	FER-MAS®	FSP214-70306-s	14X5078120 / 14Y5011240	PIN	Equalizer Bar
	FER-MAS®	FSZ201-7085145-s	14Y5011250	BUSHING	Equalizer Bar
	SPB	GE259-409064-s	0713704006	BUSHING	Blade Lift Cylinder (Barrel/Rod End)
	SPB	GE259-609041-s	14Y5011460	BUSHING	Equalizer Bar
	SPB	GE259-5011080-s	0713705008	BUSHING	Blade Tilt/Angle Cylinder (Barrel/Rod End)
TEF-MET®	TFZ 7035	7075210701	BUSHING	Ripper Cylinder (Inner Part) Tilt & Pitch Cylinder (Inner Part)	



	Parts Compatible With :				Model :
	KOMATSU®				D68
					Dozer
	Bearing Type	SBS PN	Genuine PN	Part Name	Application
	SPB	GE259-4510072-s	0713704507	BUSHING	Angle Cylinder (Rod End)

	Parts Compatible With :				Model :
	KOMATSU®				D70
					Dozer
	Bearing Type	SBS PN	Genuine PN	Part Name	Application
	FER-MAS®	FSP214-70306-s	14X5078120 / 14Y5011240	PIN	Equalizer Bar
	SPB	GE259-609041-s	14Y5011460	BUSHING	Equalizer Bar



SPB: Spherical Plain Bearings | FER-MAS®: Hardened Steel Bush | FER-MAN®: Hardened Manganese Steel | TEF-MET®: PTFE Coated Bush
 BRO-MAS®: High Strength Bronze Bush | BIV-MET®: Bimetal Steel/Bronze | COM-KU®/M: Fiberglass Composite

Disclaimer

All brand names, model names or marks are owned by their respective manufacturers. SBS – Singa Bearings Solutions Pte Ltd has no affiliation with the original equipment manufacturer. These terms are used for identification purposes only and are not intended to indicate affiliation with or approval by the OEM. All parts are manufactured by, for and warranted by SBS – Singa Bearings Solutions Pte Ltd and are not manufactured by, purchased from or warranted by the original equipment manufacturer.

	Parts Compatible With :				Model :
	KOMATSU®				D85
					Dozer
	Bearing Type	SBS PN	Genuine PN	Part Name	Application
	FER-MAS®	FSP214-60296-s	14Z5031530	PIN	Equalizer Bar
	FER-MAS®	FSP214-70306-s	14X5078120 / 14Y5011240	PIN	Equalizer Bar
	FER-MAS®	FSZ201-7085145-s	14Y5011250	BUSHING	Equalizer Bar
	FER-MAS®	FSZ201-708450-s	1756312540	BUSHING	Rotor Lift Cylinder - Trunnion
	SPB	GE259-609041-s	14Y5011460	BUSHING	Equalizer Bar
	SPB	GE259-4510072-s	0713704507	BUSHING	Blade Lift Cylinder (Rod End)
	TEF-MET®	TFZ 7035	7075210701	BUSHING	Ripper Cylinder (Inner Part)

	Parts Compatible With :				Model :
	KOMATSU®				D135
					Dozer
	Bearing Type	SBS PN	Genuine PN	Part Name	Application
	FER-MAS®	FSZ201-708450-s	1756312540	BUSHING	Blade Lift Cylinder - Trunnion



	Parts Compatible With :				Model :
	KOMATSU®				D150
					Dozer
	Bearing Type	SBS PN	Genuine PN	Part Name	Application
	FER-MAS®	FSZ201-708450-s	1756312540	BUSHING	Blade Lift Cylinder - Trunnion

SPB: Spherical Plain Bearings | FER-MAS®: Hardened Steel Bush | FER-MAN®: Hardened Manganese Steel | TEF-MET®: PTFE Coated Bush
 BRO-MAS®: High Strength Bronze Bush | BIV-MET®: Bimetal Steel/Bronze | COM-KU®/M: Fiberglass Composite

Disclaimer

All brand names, model names or marks are owned by their respective manufacturers. SBS – Singa Bearings Solutions Pte Ltd has no affiliation with the original equipment manufacturer. These terms are used for identification purposes only and are not intended to indicate affiliation with or approval by the OEM. All parts are manufactured by, for and warranted by SBS – Singa Bearings Solutions Pte Ltd and are not manufactured by, purchased from or warranted by the original equipment manufacturer.

	Parts Compatible With :				Model :
	KOMATSU®				D155
					Dozer
	Bearing Type	SBS PN	Genuine PN	Part Name	Application
	BIV-MET®	BIZ 125135100-s	1756115450	BUSHING	Blade Lift Cylinder- Trunnion (Main Frame) Blade Lift Cylinder - Trunnion (Radiator Guard)
	BIV-MET®	BIZ 14815875-s	17A5011130	BUSHING	Trackframe Link - Outer
	BIV-MET®	BIZ 17518595-s	17A5041210	BUSHING	Trackframe Link - Inner
	FER-MAS®	FSB210-9511058-s	17A5042211	BUSHING	Main Frame
	FER-MAS®	FSB210-9511588-s	17A5042131	BUSHING	Equalizer Bar - Suspension
	FER-MAS®	FSZ201-708450-s	1756312540	BUSHING	Blade Lift Cylinder - Trunnion
	FER-MAS®	FSP214-70304-s	17A5042140	PIN	Equalizer Bar - Suspension
	FER-MAS®	FSP214-95334-s	17A5042120	PIN	Equalizer Bar - Suspension
	SPB	GE259-5011080-s	0713705008	BUSHING	Blade Tilt/Angle Cylinder (Barrel/Rod End)
	SPB	GE259-7013075-s	17A5042151	BUSHING	Equalizer Bar - Suspension
	TEF-MET®	TFZ 11040	0717701140 / 7075215750	BUSHING	Trackframe - Recoil Spring
	TEF-MET®	TFZ 10035	0717701035	BUSHING	Dump Cylinder (Barrel Inner Part)
BRO-MAS®	BSA114-1031504.6-s	1953062650	PLATE	Trackframe	

	Parts Compatible With :				Model :
	KOMATSU®				D355
					Dozer
	Bearing Type	SBS PN	Genuine PN	Part Name	Application
	SPB	GE259-5512590-s	0713705509	BUSHING	Blade Lift Cylinder (Rod End)
	FER-MAS®	FSZ201-708450-s	1756312540	BUSHING	Blade Lift Cylinder - Trunnion
	TEF-MET®	TFZ 10035	0717701035	BUSHING	Blade Tilt Cylinder (Barrel Inner Part)



SPB: Spherical Plain Bearings | FER-MAS®: Hardened Steel Bush | FER-MAN®: Hardened Manganese Steel | TEF-MET®: PTFE Coated Bush
 BRO-MAS®: High Strength Bronze Bush | BIV-MET®: Bimetal Steel/Bronze | COM-KU®/M: Fiberglass Composite

Disclaimer

All brand names, model names or marks are owned by their respective manufacturers. SBS – Singa Bearings Solutions Pte Ltd has no affiliation with the original equipment manufacturer. These terms are used for identification purposes only and are not intended to indicate affiliation with or approval by the OEM. All parts are manufactured by, for and warranted by SBS – Singa Bearings Solutions Pte Ltd and are not manufactured by, purchased from or warranted by the original equipment manufacturer.

	Parts Compatible With :				Model :
	KOMATSU®				D375
					Dozer
	Bearing Type	SBS PN	Genuine PN	Part Name	Application
	BIV-MET®	BIZ 175185105-s	1955022210	BUSHING	Trackframe Link - Outer Pivot Shaft
	BIV-MET®	BIZ 210220125-s	1955022190	BUSHING	"Trackframe Link - Inner Pivot Shaft"
	BRO-MAS®	BSA114-1031504.6-s	1953062650	PLATE	Trackframe
	FER-MAS®	FSB234-120140120-s	1955041132	BUSHING	Equalizer Bar - Center Pivot
	FER-MAS®	FSZ201-100115150	7077610120	BUSHING	Ripper Tilt/Lift Cylinder (Barrel End)
	FER-MAS®	FSZ201-10011592	7077610110	BUSHING	Ripper Tilt/Lift Cylinder (Rod End)
	FER-MAS®	FSZ234-120140199-s	1957871220	BUSHING	Ripper Beam - Arm
	FER-MAS®	FSZ201-658088	7077665570	BUSHING	Blade Lift Cylinder (Rod End)
	FER-MAS®	FSZ210-10513089-s	1956141140	BUSHING	Blade Lift Cylinder - Trunnion (Support)
	FER-MAS®	FS218222-110132	1953062100	PIN ASSY	Trackframe Bogie
	FER-MAS®	FSZ211-364379410-s	1953034121	BUSHING	Trackframe - Recoil Spring
	SPB	GE259-75160100-s	1957151263	BUSHING	Blade Tilt Cylinder (Rod End)
	SPB	GE259-9516090-s	1955041161	BUSHING	Equalizer Bar
TEF-MET®	TFZ 380110	1953031221	BUSHING	Trackframe Suspension	



	Parts Compatible With :				Model :
	KOMATSU®				D455
					Dozer
	Bearing Type	SBS PN	Genuine PN	Part Name	Application
	TEF-MET®	TFZ 10035	0717701035	BUSHING	Blade Lift Cylinder (Barrel Inner Part)



	Parts Compatible With :				Model :
	KOMATSU®				D460/465
					Dozer
	Bearing Type	SBS PN	Genuine PN	Part Name	Application
	TEF-MET®	TFZ 10035	0717701035	BUSHING	Hoist Cylinder (Inner Part)



SPB: Spherical Plain Bearings | FER-MAS®: Hardened Steel Bush | FER-MAN®: Hardened Manganese Steel | TEF-MET®: PTFE Coated Bush
 BRO-MAS®: High Strength Bronze Bush | BIV-MET®: Bimetal Steel/Bronze | COM-KU®/M: Fiberglass Composite



Disclaimer

All brand names, model names or marks are owned by their respective manufacturers. SBS – Singa Bearings Solutions Pte Ltd has no affiliation with the original equipment manufacturer. These terms are used for identification purposes only and are not intended to indicate affiliation with or approval by the OEM. All parts are manufactured by, for and warranted by SBS – Singa Bearings Solutions Pte Ltd and are not manufactured by, purchased from or warranted by the original equipment manufacturer.

	Parts Compatible With :				Model :
	KOMATSU®				D475
					Dozer
	Bearing Type	SBS PN	Genuine PN	Part Name	Application
	FER-MAS®	FSZ201-658088	7077665570	BUSHING	Blade Lift Cylinder (Rod End)
	TEF-MET®	TFZ 12045	7075290980/ 7075290981	BUSHING	Ripper Lift Cylinder - Inner Part

	Parts Compatible With :				Model :
	KOMATSU®				D575
					Dozer
	Bearing Type	SBS PN	Genuine PN	Part Name	Application
	TEF-MET®	TFZ 16080	7075291350 / 7075291351	BUSHING	Tilt Cylinder (Barrel Inner Part)

	Parts Compatible With :				Model :
	KOMATSU®				PC220
					Excavator
	Bearing Type	SBS PN	Genuine PN	Part Name	Application
	TEF-MET®	TFZ 10035	0717701035	BUSHING	Bucket Cylinder - Inner Part



	Parts Compatible With :				Model :
	KOMATSU®				PC228
					Excavator
	Bearing Type	SBS PN	Genuine PN	Part Name	Application
	FER-MAS®	FSZ201-100115106	7077610130	BUSHING	Blade Cylinder (Rod End)



	Parts Compatible With :				Model :
	KOMATSU®				PC240
					Excavator
	Bearing Type	SBS PN	Genuine PN	Part Name	Application
	TEF-MET®	TFZ 10035	0717701035	BUSHING	Bucket Cylinder - Inner Part



SPB: Spherical Plain Bearings | FER-MAS®: Hardened Steel Bush | FER-MAN®: Hardened Manganese Steel | TEF-MET®: PTFE Coated Bush
 BRO-MAS®: High Strength Bronze Bush | BIV-MET®: Bimetal Steel/Bronze | COM-KU®/M: Fiberglass Composite



Disclaimer

All brand names, model names or marks are owned by their respective manufacturers. SBS – Singa Bearings Solutions Pte Ltd has no affiliation with the original equipment manufacturer. These terms are used for identification purposes only and are not intended to indicate affiliation with or approval by the OEM. All parts are manufactured by, for and warranted by SBS – Singa Bearings Solutions Pte Ltd and are not manufactured by, purchased from or warranted by the original equipment manufacturer.

	Parts Compatible With :				Model :
	KOMATSU®				PC270
					Excavator
	Bearing Type	SBS PN	Genuine PN	Part Name	Application
	FER-MAS®	FSZ201-100115106	7077610130	BUSHING	Arm Cylinder (Barrel End)

	Parts Compatible With :				Model :
	KOMATSU®				PC300 series
					Excavator
	Bearing Type	SBS PN	Genuine PN	Part Name	Application
	FER-MAS®	FSZ201-100115106	7077610130	BUSHING	Boom Cylinder (Rod End) Arm Cylinder (Barrel End)
	TEF-MET®	TFZ 11040	0717701140 / 7075215750	BUSHING	Arm Cylinder - Inner Part



	Parts Compatible With :				Model :
	KOMATSU®				PC350 series
					Excavator
	Bearing Type	SBS PN	Genuine PN	Part Name	Application
	TEF-MET®	TFZ 14060	7075291170 / 7075291171	BUSHING	Boom Cylinder (Barrel Inner Part)



	Parts Compatible With :				Model :
	KOMATSU®				PC400 series
					Excavator
	Bearing Type	SBS PN	Genuine PN	Part Name	Application
	FER-MAS®	FSZ201-10011596	7077610140	BUSHING	Bucket/Arm Cylinder (Rod End)
	FER-MAS®	FSZ201-100115106	7077610130	BUSHING	Bucket/Arm Cylinder (Barrel End) Boom Cylinder (Rod End)
	FER-MAS®	FSZ201-110125116	7077611130	BUSHING	Bucket/Arm Cylinder (Barrel End) Boom Cylinder (Rod End)
	TEF-MET®	TFZ 11040	0717701140 / 7075215750	BUSHING	Boom/Bucket Cylinder - Inner Part
TEF-MET®	TFZ 12045	7075290980/ 7075290981	BUSHING	Arm Cylinder (Barrel Inner Part)	



SPB: Spherical Plain Bearings | FER-MAS®: Hardened Steel Bush | FER-MAN®: Hardened Manganese Steel | TEF-MET®: PTFE Coated Bush
 BRO-MAS®: High Strength Bronze Bush | BIV-MET®: Bimetal Steel/Bronze | COM-KU®/M: Fiberglass Composite

Disclaimer

All brand names, model names or marks are owned by their respective manufacturers. SBS – Singa Bearings Solutions Pte Ltd has no affiliation with the original equipment manufacturer. These terms are used for identification purposes only and are not intended to indicate affiliation with or approval by the OEM. All parts are manufactured by, for and warranted by SBS – Singa Bearings Solutions Pte Ltd and are not manufactured by, purchased from or warranted by the original equipment manufacturer.

	Parts Compatible With :				Model :
	KOMATSU®				PC450 series Excavator
	Bearing Type	SBS PN	Genuine PN	Part Name	Application
	FER-MAS®	FSZ201-10011596	7077610140	BUSHING	Bucket Cylinder (Rod End)
	FER-MAS®	FSZ201-100115106	7077610130	BUSHING	Bucket Cylinder (Barrel End)
	FER-MAS®	FSZ201-110125116	7077611130	BUSHING	Bucket/Arm Cylinder (Barrel End) Boom Cylinder (Rod End)
TEF-MET®	TFZ 12045	7075290980/ 7075290981	BUSHING	Arm Cylinder (Barrel Inner Part)	

	Parts Compatible With :				Model :
	KOMATSU®				PC550 Excavator
	Bearing Type	SBS PN	Genuine PN	Part Name	Application
	FER-MAS®	FSZ201-110125116	7077611130	BUSHING	Bucket/Arm Cylinder (Barrel End)
	TEF-MET®	TFZ 12045	7075290980/ 7075290981	BUSHING	Arm Cylinder (Barrel Inner Part)



	Parts Compatible With :				Model :
	KOMATSU®				PC600 Excavator
	Bearing Type	SBS PN	Genuine PN	Part Name	Application
	FER-MAS®	FSZ201-115135132-s	2097253170	BUSHING	Bucket Linkage
	FER-MAS®	FSZ201-110125116	7077611130	BUSHING	Bucket Cylinder (Barrel End)
	TEF-MET®	TFZ 12045	7075290980/ 7075290981	BUSHING	Boom Cylinder - Inner Part
TEF-MET®	TFZ 14060	7075291170 / 7075291171	BUSHING	Arm Cylinder (Barrel Inner Part)	

SPB: Spherical Plain Bearings | FER-MAS®: Hardened Steel Bush | FER-MAN®: Hardened Manganese Steel | TEF-MET®: PTFE Coated Bush
 BRO-MAS®: High Strength Bronze Bush | BIV-MET®: Bimetal Steel/Bronze | COM-KU®/M: Fiberglass Composite

Disclaimer

All brand names, model names or marks are owned by their respective manufacturers. SBS – Singa Bearings Solutions Pte Ltd has no affiliation with the original equipment manufacturer. These terms are used for identification purposes only and are not intended to indicate affiliation with or approval by the OEM. All parts are manufactured by, for and warranted by SBS – Singa Bearings Solutions Pte Ltd and are not manufactured by, purchased from or warranted by the original equipment manufacturer.



	Parts Compatible With :				Model :
	KOMATSU®				PC650
					Excavator
	Bearing Type	SBS PN	Genuine PN	Part Name	Application
	SPB	GE259-11519598-s	7074611520	BUSHING	Bucket/Arm Cylinder (Rod End) Boom Cylinder (Rod End)
	SPB	GE259-140230110-s	7074614010	BUSHING	Bucket Cylinder (Barrel End)
	SPB	GE259-13020095110-s	7074613010	BUSHING	"Bucket/Arm Cylinder (Barrel End) Boom Cylinder (Rod End)"
	FER-MAS®	FSB214-13015074-s	2099395451	BUSHING	Bucket Hinge
	FER-MAS®	FSB201-130170125-s	2099395410	BUSHING	Bucket Hinge
	FER-MAS®	FSB201-130165150-s	2099445230	BUSHING	Arm Hinge (Bucket)
	FER-MAS®	FSZ201-115135132-s	2097253170	BUSHING	Bucket Linkage
	FER-MAS®	FSZ210-140160132-s	2097211251 / 21T7073170	BUSHING	Arm Hinge (Boom) Boom Hinge (Frame)
	FER-MAS®	FSZ201-110125116	7077611130	BUSHING	Bucket Cylinder (Barrel End)
	TEF-MET®	TFZ 12045	7075290980/ 7075290981	BUSHING	Boom Cylinder - Inner Part
	TEF-MET®	TFZ 14060	7075291170 / 7075291171	BUSHING	Arm Cylinder (Barrel Inner Part)
	TEF-MET®	TFZ 16080	7075291350 / 7075291351	BUSHING	Arm Cylinder (Barrel Inner Part)
TEF-MET®	TFZ 10035	0717701035	BUSHING	Idler Cushion	



	Parts Compatible With :				Model :
	KOMATSU®				PC700
					Excavator
	Bearing Type	SBS PN	Genuine PN	Part Name	Application
	FER-MAS®	FSZ201-110125116	7077611130	BUSHING	Bucket Cylinder (Barrel End)
	FER-MAS®	FSZ201-115135132-s	2097253170	BUSHING	Bucket Linkage
	TEF-MET®	TFZ 12045	7075290980/ 7075290981	BUSHING	Boom Cylinder - Inner Part
	TEF-MET®	TFZ 14060	7075291170 / 7075291171	BUSHING	Arm Cylinder (Barrel Inner Part)

SPB: Spherical Plain Bearings | FER-MAS®: Hardened Steel Bush | FER-MAN®: Hardened Manganese Steel | TEF-MET®: PTFE Coated Bush
 BRO-MAS®: High Strength Bronze Bush | BIV-MET®: Bimetal Steel/Bronze | COM-KU®/M: Fiberglass Composite

Disclaimer

All brand names, model names or marks are owned by their respective manufacturers. SBS – Singa Bearings Solutions Pte Ltd has no affiliation with the original equipment manufacturer. These terms are used for identification purposes only and are not intended to indicate affiliation with or approval by the OEM. All parts are manufactured by, for and warranted by SBS – Singa Bearings Solutions Pte Ltd and are not manufactured by, purchased from or warranted by the original equipment manufacturer.

	Parts Compatible With :				Model :
	KOMATSU®				PC710
					Excavator
	Bearing Type	SBS PN	Genuine PN	Part Name	Application
	SPB	GE259-11519598-s	7074611520	BUSHING	Bucket/Arm Cylinder (Rod End) Boom Cylinder (Rod End)
	SPB	GE259-13020095110-s	7074613010	BUSHING	Bucket/Arm Cylinder (Barrel End) Boom Cylinder (Rod End)
	FER-MAS®	FSB201-130170125-s	2099395410	BUSHING	Bucket Hinge
	FER-MAS®	FSB214-13015074-s	2099395451	BUSHING	Bucket Hinge
	FER-MAS®	FSB201-130165150-s	2099445230	BUSHING	Arm Hinge (Bucket)
	FER-MAS®	FSZ210-140160132-s	2097211251 / 21T7073170	BUSHING	Arm Hinge (Boom)

	Parts Compatible With :				Model :
	KOMATSU®				PC750
					Excavator
	Bearing Type	SBS PN	Genuine PN	Part Name	Application
	FER-MAS®	FSB201-130170125-s	2099395410	BUSHING	Bucket Hinge
	FER-MAS®	FSB201-130165150-s	2099445230	BUSHING	Arm Hinge (Bucket)
	FER-MAS®	FSZ210-140160132-s	2097211251 / 21T7073170	BUSHING	Arm Hinge (Boom)
	FER-MAS®	FSZ201-140160179-s	2097071350	BUSHING	Bucket Linkage
	FER-MAS®	FSZ201-110125116	7077611130	BUSHING	Bucket Cylinder (Barrel End)
	SPB	GE259-13020095110-s	7074613010	BUSHING	Bucket/Arm Cylinder (Barrel End) Boom Cylinder (Rod End)
	SPB	GE259-140230110-s	7074614010	BUSHING	Bucket Cylinder (Barrel End)
	SPB	GE259-11519598-s	7074611520	BUSHING	Bucket/Arm Cylinder (Rod End) Boom Cylinder (Rod End)
	TEF-MET®	TFZ 16080	7075291350 / 7075291351	BUSHING	Arm Cylinder (Barrel Inner Part)

SPB: Spherical Plain Bearings | FER-MAS®: Hardened Steel Bush | FER-MAN®: Hardened Manganese Steel | TEF-MET®: PTFE Coated Bush
 BRO-MAS®: High Strength Bronze Bush | BIV-MET®: Bimetal Steel/Bronze | COM-KU®/M: Fiberglass Composite

Disclaimer



All brand names, model names or marks are owned by their respective manufacturers. SBS – Singa Bearings Solutions Pte Ltd has no affiliation with the original equipment manufacturer. These terms are used for identification purposes only and are not intended to indicate affiliation with or approval by the OEM. All parts are manufactured by, for and warranted by SBS – Singa Bearings Solutions Pte Ltd and are not manufactured by, purchased from or warranted by the original equipment manufacturer.

		Parts Compatible With :			Model :	
		KOMATSU®			PC800 Excavator	
  		Bearing Type	SBS PN	Genuine PN	Part Name	Application
		FER-MAS®	FSB201-130165150-s	2099445230	BUSHING	Arm Hinge (Bucket)
		FER-MAS®	FSZ210-140160132-s	2097211251 / 21T7073170	BUSHING	Arm Hinge (Boom)
		FER-MAS®	FSB201-130170125-s	2099395410	BUSHING	Bucket Hinge
		FER-MAS®	FSB214-13015074-s	2099395451	BUSHING	Bucket Hinge
		FER-MAS®	FSZ201-115135132-s	2097253170	BUSHING	Bucket Linkage
		FER-MAS®	FSZ201-140160179-s	2097071350	BUSHING	Bucket Linkage
		FER-MAS®	FSZ201-110125116	7077611130	BUSHING	Bucket/Arm Cylinder (Barrel End)
		SPB	GE259-11519598-s	7074611520	BUSHING	Boom/Arm Cylinder (Rod End)
		SPB	GE259-13020095110-s	7074613010	BUSHING	Boom/Arm Cylinder (Barrel End)
		SPB	GE259-140230110-s	7074614010	BUSHING	Bucket Cylinder (Barrel End)
		TEF-MET®	TFZ 12045	7075290980 / 7075290981	BUSHING	Arm Cylinder (Barrel Inner Part)
TEF-MET®	TFZ 14060	7075291170 / 7075291171	BUSHING	Boom Cylinder (Barrel Inner Part)		
TEF-MET®	TFZ 16080	7075291350 / 7075291351	BUSHING	Bucket Cylinder (Barrel Inner Part)		

SPB: Spherical Plain Bearings | FER-MAS®: Hardened Steel Bush | FER-MAN®: Hardened Manganese Steel | TEF-MET®: PTFE Coated Bush
 BRO-MAS®: High Strength Bronze Bush | BIV-MET®: Bimetal Steel/Bronze | COM-KU®/M: Fiberglass Composite

Disclaimer



All brand names, model names or marks are owned by their respective manufacturers. SBS – Singa Bearings Solutions Pte Ltd has no affiliation with the original equipment manufacturer. These terms are used for identification purposes only and are not intended to indicate affiliation with or approval by the OEM. All parts are manufactured by, for and warranted by SBS – Singa Bearings Solutions Pte Ltd and are not manufactured by, purchased from or warranted by the original equipment manufacturer.



	Parts Compatible With :				Model :
	KOMATSU®				PC850 Excavator
	Bearing Type	SBS PN	Genuine PN	Part Name	Application
	FER-MAS®	FSB201-130165150-s	2099445230	BUSHING	Arm Hinge (Bucket)
	FER-MAS®	FSB201-130170125-s	2099395410	BUSHING	Bucket Hinge
	FER-MAS®	FSB214-13015074-s	2099395451	BUSHING	Bucket Hinge
	FER-MAS®	FSZ201-115135132-s	2097253170	BUSHING	Bucket Linkage
	FER-MAS®	FSZ201-140160179-s	2097071350	BUSHING	Bucket Linkage
	FER-MAS®	FSZ201-110125116	7077611130	BUSHING	Bucket/Arm Cylinder (Barrel End)
	SPB	GE259-11519598-s	7074611520	BUSHING	Boom Cylinder (Rod End)
	SPB	GE259-13020095110-s	7074613010	BUSHING	Boom Cylinder (Barrel End)
	SPB	GE259-140230110-s	7074614010	BUSHING	Bucket Cylinder (Barrel End)
	TEF-MET®	TFZ 12045	7075290980/ 7075290981	BUSHING	Arm Cylinder (Barrel Inner Part)
	TEF-MET®	TFZ 14060	7075291170 / 7075291171	BUSHING	Boom Cylinder (Barrel Inner Part)
	TEF-MET®	TFZ 16080	7075291350 / 7075291351	BUSHING	Bucket Cylinder (Barrel Inner Part)

SPB: Spherical Plain Bearings | FER-MAS®: Hardened Steel Bush | FER-MAN®: Hardened Manganese Steel | TEF-MET®: PTFE Coated Bush
 BRO-MAS®: High Strength Bronze Bush | BIV-MET®: Bimetal Steel/Bronze | COM-KU®/M: Fiberglass Composite

Disclaimer

All brand names, model names or marks are owned by their respective manufacturers. SBS – Singa Bearings Solutions Pte Ltd has no affiliation with the original equipment manufacturer. These terms are used for identification purposes only and are not intended to indicate affiliation with or approval by the OEM. All parts are manufactured by, for and warranted by SBS – Singa Bearings Solutions Pte Ltd and are not manufactured by, purchased from or warranted by the original equipment manufacturer.



	Parts Compatible With :				Model :
	KOMATSU®				PC1000 Excavator
	Bearing Type	SBS PN	Genuine PN	Part Name	Application
	FER-MAS®	FSZ210-140160164-s	21N7012170	BUSHING	Arm Hinge (Bucket)
	SPB	GE259-160255120-s	7074616030	BUSHING	Arm Cylinder (Barrel/Rod End)
	SPB	GE259-140230110-s	7074614010	BUSHING	Boom/Bucket Cylinder (Barrel/Rod End)
	SPB	GE259-13020095110-s	7074613010	BUSHING	Bucket/Arm Cylinder (Barrel End)
	SPB	GE259-11519598-s	7074611520	BUSHING	Boom Cylinder (Rod End)
	TEF-MET®	TFZ 16080	7075291350 / 7075291351	BUSHING	Boom/Bucket Cylinder (Barrel Inner Part)



	Parts Compatible With :				Model :
	KOMATSU®				PC1100 Excavator
	Bearing Type	SBS PN	Genuine PN	Part Name	Application
	FER-MAS®	FSZ210-140160164-s	21N7012170	BUSHING	Arm Hinge (Bucket)
	FER-MAS®	FSB210-140175192-s	21N7032550	BUSHING	Arm Hinge (Bucket)
	FER-MAS®	FSZ201-160180146	7077616030	BUSHING	Arm Cylinder (Barrel End)
	FER-MAS®	FSZ210-160180159-s	21N7031160	BUSHING	Boom Hinge (Frame)
	SPB	GE259-160255120-s	7074616030	BUSHING	Arm Cylinder (Rod End)
	SPB	GE259-140230110-s	7074614010	BUSHING	Boom Cylinder (Barrel End) Bucket Cylinder (Rod End)
	SPB	GE259-13020095110-s	7074613010	BUSHING	Bucket Cylinder (Barrel End)
	TEF-MET®	TFZ 16080	7075291350 / 7075291351	BUSHING	Boom Cylinder (Barrel Inner Part)



SPB: Spherical Plain Bearings | FER-MAS®: Hardened Steel Bush | FER-MAN®: Hardened Manganese Steel | TEF-MET®: PTFE Coated Bush
 BRO-MAS®: High Strength Bronze Bush | BIV-MET®: Bimetal Steel/Bronze | COM-KU®/M: Fiberglass Composite

Disclaimer

All brand names, model names or marks are owned by their respective manufacturers. SBS – Singa Bearings Solutions Pte Ltd has no affiliation with the original equipment manufacturer. These terms are used for identification purposes only and are not intended to indicate affiliation with or approval by the OEM. All parts are manufactured by, for and warranted by SBS – Singa Bearings Solutions Pte Ltd and are not manufactured by, purchased from or warranted by the original equipment manufacturer.

	Parts Compatible With :				Model :
	KOMATSU®				PC1250 Excavator
	Bearing Type	SBS PN	Genuine PN	Part Name	Application
	FER-MAS®	FSB210-140175192-s	21N7032550	BUSHING	Arm Hinge (Bucket)
	FER-MAS®	FSZ210-140160164-s	21N7012170	BUSHING	Arm Hinge (Bucket)
	FER-MAS®	FSZ210-160180159-s	21N7031160	BUSHING	Boom Hinge (Frame)
	FER-MAS®	FSZ201-100115106	7077610130	BUSHING	Bucket Cylinder (Rod End) Bottom Dump Cylinder (Rod End)
	FER-MAS®	FSZ201-10011596	7077610140	BUSHING	Bucket Cylinder (Barrel End)
	FER-MAS®	FSZ201-160180146	7077616030	BUSHING	Arm Cylinder (Barrel End)
	SPB	GE259-140230110-s	7074614010	BUSHING	Bucket Cylinder (Rod End) Boom Cylinder (Barrel End)
	SPB	GE259-13020095110-s	7074613010	BUSHING	Bucket Cylinder (Barrel End)
	SPB	GE259-160255120-s	7074616030	BUSHING	Arm Cylinder (Rod End)
	TEF-MET®	TFZ 11055	7075211630	BUSHING	Bucket Cylinder (Barrel Inner Part)
TEF-MET®	TFZ 16080	7075291350 / 7075291351	BUSHING	Boom Cylinder (Barrel Inner Part)	

	Parts Compatible With :				Model :
	KOMATSU®				PC1600 Excavator
	Bearing Type	SBS PN	Genuine PN	Part Name	Application
	FER-MAS®	FSZ210-140160132-s	2097211251 / 21T7073170	BUSHING	Arm Hinge (Bucket) Bucket Linkage
	TEF-MET®	TFZ 16080	7075291350 / 7075291351	BUSHING	Arm Cylinder (Barrel Inner Part)
	SPB	GE259-140230110-s	7074614010	BUSHING	Arm Cylinder (Barrel/Rod End)

	Parts Compatible With :				Model :
	KOMATSU®				PC1800 Excavator
	Bearing Type	SBS PN	Genuine PN	Part Name	Application
	FER-MAS®	FSZ210-140160132-s	2097211251 / 21T7073170	BUSHING	Arm Hinge (Bucket) Bucket Linkage
	TEF-MET®	TFZ 16080	7075291350 / 7075291351	BUSHING	Arm Cylinder (Barrel Inner Part)
	SPB	GE259-140230110-s	7074614010	BUSHING	Arm Cylinder (Barrel/Rod End)

SPB: Spherical Plain Bearings | FER-MAS®: Hardened Steel Bush | FER-MAN®: Hardened Manganese Steel | TEF-MET®: PTFE Coated Bush
 BRO-MAS®: High Strength Bronze Bush | BIV-MET®: Bimetal Steel/Bronze | COM-KU®/M: Fiberglass Composite

Disclaimer



All brand names, model names or marks are owned by their respective manufacturers. SBS – Singa Bearings Solutions Pte Ltd has no affiliation with the original equipment manufacturer. These terms are used for identification purposes only and are not intended to indicate affiliation with or approval by the OEM. All parts are manufactured by, for and warranted by SBS – Singa Bearings Solutions Pte Ltd and are not manufactured by, purchased from or warranted by the original equipment manufacturer.



	Parts Compatible With :				Model :
	KOMATSU®				PC2000 Excavator
	Bearing Type	SBS PN	Genuine PN	Part Name	Application
   	FER-MAS®	FSP214-140562-s	21T7033171	PIN	Bucket Hinge
	FER-MAS®	FSP214-140604-s	21T7033250	PIN	Bucket Linkage
	FER-MAS®	FSB210-14016089-s	21T7034321	BUSHING	Bucket Hinge
	FER-MAS®	FSB210-140185109-s	21T7034312	BUSHING	Bucket Hinge
	FER-MAS®	FSZ201-120135135	7077612180	BUSHING	Bucket Cylinder (Barrel End)
	FER-MAS®	FSZ201-140160130	7077614050	BUSHING	Bucket Cylinder (Rod End)
	FER-MAS®	FSZ210-140160132-s	2097211251 / 21T7073170	BUSHING	Arm Hinge (Bucket) Bucket Linkage
	FER-MAS®	FSZ210-180210150-s	21T7031250	BUSHING	Boom Cylinder Hinge
	FER-MAS®	FSZ210-180235120-s	21T7031240	BUSHING	Boom Cylinder Hinge
	SPB	GE259-140220110-s	7074614050	BUSHING	Arm Cylinder (Barrel/Rod End)
	SPB	GE259-180285130-s	7074618050	BUSHING	Boom Cylinder (Barrel/Rod End)
	TEF-MET®	TFZ 14060	7075291170 / 7075291171	BUSHING	Bucket Cylinder (Barrel Inner Part)
	TEF-MET®	TFZ 16080	7075291350 / 7075291351	BUSHING	Arm Cylinder (Barrel Inner Part)
	TEF-MET®	TFZ 20080	7075291760 / 7075291761	BUSHING	Boom Cylinder (Barrel Inner Part)



SPB: Spherical Plain Bearings | FER-MAS®: Hardened Steel Bush | FER-MAN®: Hardened Manganese Steel | TEF-MET®: PTFE Coated Bush
 BRO-MAS®: High Strength Bronze Bush | BIV-MET®: Bimetal Steel/Bronze | COM-KU®/M: Fiberglass Composite

Disclaimer

All brand names, model names or marks are owned by their respective manufacturers. SBS – Singa Bearings Solutions Pte Ltd has no affiliation with the original equipment manufacturer. These terms are used for identification purposes only and are not intended to indicate affiliation with or approval by the OEM. All parts are manufactured by, for and warranted by SBS – Singa Bearings Solutions Pte Ltd and are not manufactured by, purchased from or warranted by the original equipment manufacturer.

	Parts Compatible With :				Model :
	KOMATSU®				PC3000-6 Excavator
	Bearing Type	SBS PN	Genuine PN	Part Name	Application
	BRO-MAS®	BSB108-140170180-s	88215740	FLANGE BUSH	Front Shovel Boom Cylinder (Rod)
	BRO-MAS®	BSB108-170200184-s	90934340	FLANGE BUSH	Bucket Cylinder (Rod)
	BRO-MAS®	BSB108-25028082-s	92498840	FLANGE BUSH	Stick Cylinder Backhoe (Fork Type Cyl)
	BRO-MAS®	BSZ108-11013087-sa	62759740	BUSHING	Clamp Cylinder
	BRO-MAS®	BSZ108-150170120-s	91016440	BUSHING	Bucket Cylinder Backhoe (Fork Type Cyl)
	BRO-MAS®	BSZ108-170200169-s	62757240	BUSHING	Boom Cylinder (Rod & Barrel)





	Parts Compatible With :				Model :
	KOMATSU®				PC4000 Excavator
	Bearing Type	SBS PN	Genuine PN	Part Name	Application
	BRO-MAS®	BSB108-140170180-s	88215740	FLANGE BUSH	Front Shovel Boom Cylinder (Rod)
	BRO-MAS®	BSB108-170200184-s	90934340	FLANGE BUSH	Bucket Cylinder (Rod)
	BRO-MAS®	BSZ108-160180120-s	90453940	BUSHING	Bucket Cylinder (Barrel)
	BRO-MAS®	BSZ108-11013087-sa	62759740	BUSHING	Clamp Cylinder
	BRO-MAS®	BSZ108-170200169-s	62757240	BUSHING	Boom Cylinder (Rod & Barrel)
	BRO-MAS®	BSZ108-180210120-s	43077140	BUSHING	Boom Cylinder (Barrel)
	BRO-MAS®	BSZ108-190220135-s	42966840 / 97059040	BUSHING	Idler Bush
FER-MAS®	FSP214-85299	44895720	PIN	Tracklink	

	Parts Compatible With :				Model :
	KOMATSU®				PC4000-6 Excavator
	Bearing Type	SBS PN	Genuine PN	Part Name	Application
	BRO-MAS®	BSB108-26029087-s	90950440	FLANGE BUSH	Bucket Cylinder
	BRO-MAS®	BSZ108-120140102-s	62457740	BUSHING	Clamp Cylinder
	BRO-MAS®	BSZ108-170200170-s	90931240	BUSHING	Stick Cylinder



SPB: Spherical Plain Bearings | FER-MAS®: Hardened Steel Bush | FER-MAN®: Hardened Manganese Steel | TEF-MET®: PTFE Coated Bush
 BRO-MAS®: High Strength Bronze Bush | BIV-MET®: Bimetal Steel/Bronze | COM-KU®/M: Fiberglass Composite

Disclaimer

All brand names, model names or marks are owned by their respective manufacturers. SBS – Singa Bearings Solutions Pte Ltd has no affiliation with the original equipment manufacturer. These terms are used for identification purposes only and are not intended to indicate affiliation with or approval by the OEM. All parts are manufactured by, for and warranted by SBS – Singa Bearings Solutions Pte Ltd and are not manufactured by, purchased from or warranted by the original equipment manufacturer.

	Parts Compatible With :				Model :
	KOMATSU®				330M
					Rigid-Frame Truck
  	Bearing Type	SBS PN	Genuine PN	Part Name	Application
	SPB	GE259-8013070-sa	5696322880	BUSHING	Hoist Cylinder (Barrel/Rod End)
	SPB	GE259-105210145-s	5614061260	BUSHING	Front Axle (A-Frame/Main)
	SPB	GE259-8013070-s	5615062310	BUSHING	Rear Suspension Cylinder (Barrel/Rod End)
	FER-MAS®	FSB210-506465-s	5614061330	BUSHING	Main Frame Front Axle - Lever Steering Linkage (Lever-Rod)
	FER-MAS®	FSB210-607550-s	5614041120	BUSHING	Knuckle & Tie Rod
	FER-MAS®	FSB210-607562-s	5614061160	BUSHING	Knuckle & Tie Rod
	FER-MAS®	FSB210-607565-s	5614041130	BUSHING	Knuckle & Tie Rod
	FER-MAS®	FSZ210-91105160-s	5684611472	BUSHING	Dump Body Pivot Hinge
	TEF-MET®	TFZ 13040	7075211320 / 7075211321	BUSHING	Hoist Cylinder (Inner Part)
TEF-MET®	TFZ 20050	5816322291	BUSHING	Hoist Cylinder (Inner Part)	



	Parts Compatible With :				Model :
	KOMATSU®				HD320
					Rigid-Frame Truck
	Bearing Type	SBS PN	Genuine PN	Part Name	Application
	TEF-MET®	TFZ 16090	5665011180	BUSHING	Front Suspension Cylinder - (Inner Part) Rear Suspension Cylinder - (Inner Part)



	Parts Compatible With :				Model :
	KOMATSU®				HD325
					Rigid-Frame Truck
 	Bearing Type	SBS PN	Genuine PN	Part Name	Application
	SPB	GE259-409064-s	0713704006	BUSHING	Steering Linkage Rod Steering Cylinder (Barrel/Rod End)
	SPB	GE259-609044-s	5665241920	BUSHING	Front Axle - Lever Arm Rear Axle - Support Rod
TEF-MET®	TFZ 16090	5665011180	BUSHING	Front Suspension Cylinder - (Inner Part) Rear Suspension Cylinder - (Inner Part)	

SPB: Spherical Plain Bearings | FER-MAS®: Hardened Steel Bush | FER-MAN®: Hardened Manganese Steel | TEF-MET®: PTFE Coated Bush
 BRO-MAS®: High Strength Bronze Bush | BIV-MET®: Bimetal Steel/Bronze | COM-KU®/M: Fiberglass Composite

Disclaimer

All brand names, model names or marks are owned by their respective manufacturers. SBS – Singa Bearings Solutions Pte Ltd has no affiliation with the original equipment manufacturer. These terms are used for identification purposes only and are not intended to indicate affiliation with or approval by the OEM. All parts are manufactured by, for and warranted by SBS – Singa Bearings Solutions Pte Ltd and are not manufactured by, purchased from or warranted by the original equipment manufacturer.



	Parts Compatible With :				Model :
	KOMATSU®				HD405
					Rigid-Frame Truck
	Bearing Type	SBS PN	Genuine PN	Part Name	Application
	SPB	GE259-409064-s	0713704006	BUSHING	Steering Linkage Rod
	SPB	GE259-609044-s	5665241920	BUSHING	Front Axle - Lever Arm Rear Axle - Support Rod
	TEF-MET®	TFZ 16090	5665011180	BUSHING	Front Suspension Cylinder - (Inner Part)

	Parts Compatible With :				Model :
	KOMATSU®				HD460
					Rigid-Frame Truck
	Bearing Type	SBS PN	Genuine PN	Part Name	Application
	SPB	GE259-5512590-s	0713705509	BUSHING	Steering Arm - Tie Rod
	SPB	GE259-85190132-s	5694011370	BUSHING	Steering Arm - Tie Rod
	SPB	GE259-8013070-sa	5696322880	BUSHING	Hoist Cylinder (Barrel/Rod End)
	TEF-MET®	TFZ 10035	0717701035	BUSHING	Hoist Cylinder - Inner Part

SPB: Spherical Plain Bearings | FER-MAS®: Hardened Steel Bush | FER-MAN®: Hardened Manganese Steel | TEF-MET®: PTFE Coated Bush
 BRO-MAS®: High Strength Bronze Bush | BIV-MET®: Bimetal Steel/Bronze | COM-KU®/M: Fiberglass Composite

Disclaimer



All brand names, model names or marks are owned by their respective manufacturers. SBS – Singa Bearings Solutions Pte Ltd has no affiliation with the original equipment manufacturer. These terms are used for identification purposes only and are not intended to indicate affiliation with or approval by the OEM. All parts are manufactured by, for and warranted by SBS – Singa Bearings Solutions Pte Ltd and are not manufactured by, purchased from or warranted by the original equipment manufacturer.



		Parts Compatible With :			Model :
		KOMATSU®			HD465
					Rigid-Frame Truck
Bearing Type	SBS PN	Genuine PN	Part Name	Application	
	FER-MAS®	FSB210-708540-s	5694061160	BUSHING	Rear Axle Housing - Main Frame Steering Linkage - Tie Rod
	SPB	GE259-409064-s	0713704006	BUSHING	Steering Linkage Rod
	SPB	GE259-4510072-s	0713704507	BUSHING	Steering/Hoist Cylinder (Rod End)
	SPB	GE259-5512590-s	0713705509	BUSHING	Front Axle - Lever
	SPB	GE259-609044-s	5665241920	BUSHING	Front Axle Cylinder - (Rod End)
	SPB	GE259-85190132-s	5694011370	BUSHING	"Front Axle - Lever Knuckle - Tie Rod"
	SPB	GE259-701104258-s	5695241920	BUSHING	"Front Axle - Lever Rear Suspension (Barrel/Rod End)"
	SPB	GE259-7011058-s	2056356480	BUSHING	Hoist Cylinder (Barrel/Rod End)
	SPB	GE259-8013070-sa	5696322880	BUSHING	Hoist Cylinder (Barrel/Rod End)
	TEF-MET®	TFZ 10035	0717701035	BUSHING	Hoist Cylinder - Inner Part
TEF-MET®	TFZ 16090	5665011180	BUSHING	Front Suspension Cylinder - (Inner Part) Front Axle Cylinder - (Inner Part)	
TEF-MET®	TFZ 5530	0717705530	BUSHING		



SPB: Spherical Plain Bearings | FER-MAS®: Hardened Steel Bush | FER-MAN®: Hardened Manganese Steel | TEF-MET®: PTFE Coated Bush
 BRO-MAS®: High Strength Bronze Bush | BIV-MET®: Bimetal Steel/Bronze | COM-KU®/M: Fiberglass Composite

Disclaimer

All brand names, model names or marks are owned by their respective manufacturers. SBS – Singa Bearings Solutions Pte Ltd has no affiliation with the original equipment manufacturer. These terms are used for identification purposes only and are not intended to indicate affiliation with or approval by the OEM. All parts are manufactured by, for and warranted by SBS – Singa Bearings Solutions Pte Ltd and are not manufactured by, purchased from or warranted by the original equipment manufacturer.

	Parts Compatible With :				Model :
	KOMATSU®				HD605
					Rigid-Frame Truck
	Bearing Type	SBS PN	Genuine PN	Part Name	Application
	SPB	GE259-609044-s	5665241920	BUSHING	Front Axle Cylinder - (Rod End)
	SPB	GE259-5512590-s	0713705509	BUSHING	Front Axle - Lever
	SPB	GE259-701104258-s	5695241920	BUSHING	Front Axle - Lever Rear Suspension (Barrel/Rod End)
	SPB	GE259-85190132-s	5694011370	BUSHING	Front Axle - Lever Knuckle - Tie Rod
	SPB	GE259-7011058-s	2056356480	BUSHING	Hoist Cylinder (Barrel/Rod End)
	SPB	GE259-4510072-s	0713704507	BUSHING	Steering/Hoist Cylinder (Rod End)
	SPB	GE259-409064-s	0713704006	BUSHING	Steering Linkage Rod Steering Cylinder (Barrel/Rod End)
	FER-MAS®	FSB210-708540-s	5694061160	BUSHING	Rear Axle Housing - Main Frame Steering Linkage - Tie Rod
	TEF-MET®	TFZ 10035	0717701035	BUSHING	Hoist Cylinder - Inner Part
TEF-MET®	TFZ 16090	5665011180	BUSHING	Front Suspension Cylinder - (Inner Part) Front Axle Cylinder - (Inner Part)	

	Parts Compatible With :				Model :
	KOMATSU®				HD680
					Rigid-Frame Truck
	Bearing Type	SBS PN	Genuine PN	Part Name	Application
	TEF-MET®	TFZ 11040	0717701140 / 7075215750	BUSHING	Hoist Cylinder - Inner Part
	FER-MAS®	FSZ210-91105160-s	5684611472	BUSHING	Dump Body Pivot Hinge

	Parts Compatible With :				Model :
	KOMATSU®				HD780
					Rigid-Frame Truck
	Bearing Type	SBS PN	Genuine PN	Part Name	Application
	TEF-MET®	TFZ 11040	0717701140 / 7075215750	BUSHING	Hoist Cylinder - Inner Part
	SPB	GE259-8013070-sa	5696322880	BUSHING	Hoist Cylinder (Barrel/Rod End)
	FER-MAS®	FSZ210-91105160-s	5684611472	BUSHING	Dump Body Pivot Hinge

SPB: Spherical Plain Bearings | FER-MAS®: Hardened Steel Bush | FER-MAN®: Hardened Manganese Steel | TEF-MET®: PTFE Coated Bush
 BRO-MAS®: High Strength Bronze Bush | BIV-MET®: Bimetal Steel/Bronze | COM-KU®/M: Fiberglass Composite

Disclaimer



All brand names, model names or marks are owned by their respective manufacturers. SBS – Singa Bearings Solutions Pte Ltd has no affiliation with the original equipment manufacturer. These terms are used for identification purposes only and are not intended to indicate affiliation with or approval by the OEM. All parts are manufactured by, for and warranted by SBS – Singa Bearings Solutions Pte Ltd and are not manufactured by, purchased from or warranted by the original equipment manufacturer.



	Parts Compatible With :				Model :
	KOMATSU®				HD785 Rigid-Frame Truck
Bearing Type	SBS PN	Genuine PN	Part Name	Application	
	FER-MAS®	FSB210-506465-s	5614061330	BUSHING	Main Frame Front Axle - Lever Steering Linkage (Lever-Rod)
	FER-MAS®	FSB210-607550-s	5614041120	BUSHING	Knuckle & Tie Rod Steering Linkage (Main Frame)
	FER-MAS®	FSB210-607562-s	5614061160	BUSHING	Knuckle & Tie Rod Main Frame, Frame
	FER-MAS®	FSB210-607565-s	5614041130	BUSHING	Knuckle & Tie Rod Steering Linkage (Lever-Rod)
	FER-MAS®	FSB210-9010453-s	5615281170	BUSHING	Rear Axle Rod Upper & Lower Bracket (initial Size)
	FER-MAS®	FSB210-9010660-s	5618871180	BUSHING	Rear Axle Rod Upper & Lower Bracket (1st Overize)
	FER-MAS®	FSB210-9010860-s	5618871190	BUSHING	Rear Axle Rod Upper Bracket (2nd Overize)
	FER-MAS®	FSB210-9010463-s	561528A180	BUSHING	Rear Suspension Bracket (Initial Size)
	FER-MAS®	FSB210-9010665-s	561887A180	BUSHING	Rear Suspension Bracket (1st Oversize)
	FER-MAS®	FSB210-9010865-s	561887A190	BUSHING	Rear Suspension Bracket (2nd Oversize)
	FER-MAS®	FSP214-90259-s	5615281610	PIN	Rear Suspension - Lower Hinge
	FER-MAS®	FSB210-9011062-s	5615281580	BUSHING	Lower Rod Bracket
	FER-MAS®	FSB210-9011067-s	5615281570	BUSHING	Upper Rod Bracket Suspension Bracket
	FER-MAS®	FSZ210-23024574	5611375380	BUSHING	Torque Converter - Input Shaft
	FER-MAS®	FSZ210-91105160-s	5684611472	BUSHING	Dump Body Pivot Hinge
	SPB	GE259-105210145-s	5614061260	BUSHING	Front Axle (A-Frame/Main)
	SPB	GE259-5011080-s	0713705008	BUSHING	Steering Linkage Rod Steering/Hoist Cylinder (Barrel/Rod End)
	SPB	GE259-6013598-s	0713706010	BUSHING	Front Axle (A-Frame)
	SPB	GE259-8013070-sa	5696322880	BUSHING	Hoist Cylinder (Barrel/Rod End)
	SPB	GE259-8013070-s	5615062310	BUSHING	Front Suspension Cylinder (Rod End)
SPB	GE259-9014082-s	5615082310 / 5615082311	BUSHING	Rear Suspension Cylinder (Rod End) Rear Axle Support Rod	
TEF-MET®	TFZ 13040	7075211320 / 7075211321	BUSHING	Hoist Cylinder (Inner Part)	
TEF-MET®	TFZ 20050	5816322291	BUSHING	Hoist Cylinder (Inner Part)	
TEF-MET®	TFZ 21020	5615082340 / 5615082341	BUSHING	Hoist Cylinder (Inner Part)	
TEF-MET®	TFZ 11040	0717701140 / 7075215750	BUSHING	Hoist Cylinder - Inner Part	
TEF-MET®	TFZ 7035	7075210701	BUSHING	Hoist/Steering Cylinder (Inner Part)	
TEF-MET®	TFZ 180120	-	BUSHING	Front Suspension Cylinder	
TEF-MET®	TFZ 21075-s	5615082330 5615082331	BUSHING	Front/Rear Suspension (Inner Part)	





SPB: Spherical Plain Bearings | FER-MAS®: Hardened Steel Bush | FER-MAN®: Hardened Manganese Steel | TEF-MET®: PTFE Coated Bush
 BRO-MAS®: High Strength Bronze Bush | BIV-MET®: Bimetal Steel/Bronze | COM-KU®/M: Fiberglass Composite

Disclaimer

All brand names, model names or marks are owned by their respective manufacturers. SBS – Singa Bearings Solutions Pte Ltd has no affiliation with the original equipment manufacturer. These terms are used for identification purposes only and are not intended to indicate affiliation with or approval by the OEM. All parts are manufactured by, for and warranted by SBS – Singa Bearings Solutions Pte Ltd and are not manufactured by, purchased from or warranted by the original equipment manufacturer.

	Parts Compatible With :				Model :
	KOMATSU®				830E/930E
					Rigid-Frame Truck
	Bearing Type	SBS PN	Genuine PN	Part Name	Application
	SPB	GE259-139222120-si	PB0027	BEARING	Drive -Rear Axle Mounting



	Parts Compatible With :				Model :
	KOMATSU®				960E
					Rigid-Frame Truck
	Bearing Type	SBS PN	Genuine PN	Part Name	Application
	SPB	GE259-114177101-si	VL4293	BUSHING	Hoist Cylinder (Barrel End)
	SPB	GE259-14021090-s	PB8931	BUSHING	Hoist Cylinder (Rod End)



	Parts Compatible With :				Model :
	KOMATSU®				HD985
					Rigid-Frame Truck
  	Bearing Type	SBS PN	Genuine PN	Part Name	Application
	SPB	GE259-8013070-sa	5696322880	BUSHING	Hoist Cylinder (Barrel/Rod End)
	SPB	GE259-105210145-s	5614061260	BUSHING	Front Axle (A-Frame/Main)
	SPB	GE259-6013598-s	0713706010	BUSHING	Front Axle (A-Frame)
	SPB	GE259-8013070-s	5615062310	BUSHING	Front Suspension Cylinder (Rod End)
	SPB	GE259-9014082-s	5615082310 / 5615082311	BUSHING	Rear Suspension Cylinder (Rod End) Rear Axle Support Rod
	FER-MAS®	FSB210-506465-s	5614061330	BUSHING	Main Frame Front Axle - Lever Steering Linkage (Lever-Rod)
	FER-MAS®	FSB210-607550-s	5614041120	BUSHING	Knuckle & Tie Rod Steering Linkage (Main Frame)
	FER-MAS®	FSB210-607562-s	5614061160	BUSHING	Knuckle & Tie Rod Steering Linkage
	FER-MAS®	FSB210-607565-s	5614041130	BUSHING	Knuckle & Tie Rod Steering Linkage
	TEF-MET®	TFZ 13040	7075211320 / 7075211321	BUSHING	Hoist Cylinder (Inner Part)
TEF-MET®	TFZ 20050	5816322291	BUSHING	Hoist Cylinder (Inner Part)	

SPB: Spherical Plain Bearings | FER-MAS®: Hardened Steel Bush | FER-MAN®: Hardened Manganese Steel | TEF-MET®: PTFE Coated Bush
 BRO-MAS®: High Strength Bronze Bush | BIV-MET®: Bimetal Steel/Bronze | COM-KU®/M: Fiberglass Composite



Disclaimer



All brand names, model names or marks are owned by their respective manufacturers. SBS – Singa Bearings Solutions Pte Ltd has no affiliation with the original equipment manufacturer. These terms are used for identification purposes only and are not intended to indicate affiliation with or approval by the OEM. All parts are manufactured by, for and warranted by SBS – Singa Bearings Solutions Pte Ltd and are not manufactured by, purchased from or warranted by the original equipment manufacturer.

	Parts Compatible With :				Model :
	KOMATSU®				HD1200 Rigid-Frame Truck
	Bearing Type	SBS PN	Genuine PN	Part Name	Application
	TEF-MET®	TFZ 20050	5816322291	BUSHING	Hoist Cylinder (Inner Part)
	SPB	GE259-10015070	5816322691	BUSHING	Hoist Cylinder (Rod End)
	SPB	GE259-100190105-s	5625031450 / 5815021450	BUSHING	Front Suspension Cylinder (Rod End) Rear Suspension Cylinder (Barrel End) Rear Axle Rod

	Parts Compatible With :				Model :
	KOMATSU®				HD1500 Rigid-Frame Truck
	Bearing Type	SBS PN	Genuine PN	Part Name	Application
	SPB	GE259-8813977-si	VLO094	BUSHING	Hoist Cylinder (Barrel End)
	SPB	GE259-10015070	5816322691	BUSHING	Hoist Cylinder (Rod End)
	SPB	GE259-100190105-s	5625031450 / 5815021450	BUSHING	Front Suspension Cylinder (Rod End) Rear Suspension Cylinder (Barrel End) Rear Axle Rod
	SPB	GE259-6013598-s	0713706010	BUSHING	Steering Cylinder (Barrel End)

	Parts Compatible With :				Model :
	KOMATSU®				HM300/350/400 Articulated Truck
	Bearing Type	SBS PN	Genuine PN	Part Name	Application
	TEF-MET®	TFZ 7035	7075210701	BUSHING	Steering Cylinder (Inner Part)

	Parts Compatible With :				Model :
	KOMATSU®				WD600 Wheel Dozer
	Bearing Type	SBS PN	Genuine PN	Part Name	Application
	SPB	GE259-75160100-s	1957151263	BUSHING	Tilt and Pitch Cylinder (Rod End)



	Parts Compatible With :				Model :
	KOMATSU®				WD900 Wheel Dozer
	Bearing Type	SBS PN	Genuine PN	Part Name	Application
	TEF-MET®	TFZ 16080	7075291350 / 7075291351	BUSHING	Blade Tilt Cylinder (Barrel Inner Part)



SPB: Spherical Plain Bearings | FER-MAS®: Hardened Steel Bush | FER-MAN®: Hardened Manganese Steel | TEF-MET®: PTFE Coated Bush
 BRO-MAS®: High Strength Bronze Bush | BIV-MET®: Bimetal Steel/Bronze | COM-KU®/M: Fiberglass Composite



Disclaimer



All brand names, model names or marks are owned by their respective manufacturers. SBS – Singa Bearings Solutions Pte Ltd has no affiliation with the original equipment manufacturer. These terms are used for identification purposes only and are not intended to indicate affiliation with or approval by the OEM. All parts are manufactured by, for and warranted by SBS – Singa Bearings Solutions Pte Ltd and are not manufactured by, purchased from or warranted by the original equipment manufacturer.

	Parts Compatible With :				Model :
	KOMATSU®				WA150
Wheel Loader					
	Bearing Type	SBS PN	Genuine PN	Part Name	Application
	TEF-MET®	TFZ 7035	7075210701	BUSHING	Lift Cylinder (Inner Part)

	Parts Compatible With :				Model :
	KOMATSU®				WA200/250
Wheel Loader					
	Bearing Type	SBS PN	Genuine PN	Part Name	Application
	TEF-MET®	TFZ 7035	7075210701	BUSHING	Lift Cylinder (Inner Part)

	Parts Compatible With :				Model :
	KOMATSU®				WA400/420
Wheel Loader					
	Bearing Type	SBS PN	Genuine PN	Part Name	Application
	TEF-MET®	TFZ 10035	0717701035	BUSHING	Lift/Dump Cylinder (Barrel Inner Part)



	Parts Compatible With :				Model :
	KOMATSU®				WA430 WA450 WA 470 WA480
Wheel Loader					
 	Bearing Type	SBS PN	Genuine PN	Part Name	Application
	COM-KU®/S	KSZ-19020067-s	4214637120	BUSHING	Rear Axle Support
	TEF-MET®	TFZ 10035	0717701035	BUSHING	Lift/Dump Cylinder (Barrel Inner Part)



	Parts Compatible With :				Model :
	KOMATSU®				WA500
Wheel Loader					
	Bearing Type	SBS PN	Genuine PN	Part Name	Application
	TEF-MET®	TFZ 12045	7075290980/ 7075290981	BUSHING	Dump Cylinder - Inner Part
	TEF-MET®	TFZ 14060	7075291170 / 7075291171	BUSHING	Dump/Lift Cylinder (Barrel Inner Part)



SPB: Spherical Plain Bearings | FER-MAS®: Hardened Steel Bush | FER-MAN®: Hardened Manganese Steel | TEF-MET®: PTFE Coated Bush
 BRO-MAS®: High Strength Bronze Bush | BIV-MET®: Bimetal Steel/Bronze | COM-KU®/M: Fiberglass Composite



Disclaimer

All brand names, model names or marks are owned by their respective manufacturers. SBS – Singa Bearings Solutions Pte Ltd has no affiliation with the original equipment manufacturer. These terms are used for identification purposes only and are not intended to indicate affiliation with or approval by the OEM. All parts are manufactured by, for and warranted by SBS – Singa Bearings Solutions Pte Ltd and are not manufactured by, purchased from or warranted by the original equipment manufacturer.

	Parts Compatible With :				Model :
	KOMATSU®				WA600 Wheel Loader
	Bearing Type	SBS PN	Genuine PN	Part Name	Application
	FER-MAS®	FSZ210-140155135-s	4267011890	BUSHING	Lift Arm Hinge(Main Frame) Dump/Lift Cylinder (Barrel End)
	TEF-MET®	TFZ 14060	7075291170 / 7075291171	BUSHING	Dump/Lift Cylinder (Barrel Inner Part)
	TEF-MET®	TFZ 16080	7075291350 / 7075291351	BUSHING	Dump Cylinder (Barrel Inner Part)

	Parts Compatible With :				Model :
	KOMATSU®				WA700 WA800 WA900 Wheel Loader
	Bearing Type	SBS PN	Genuine PN	Part Name	Application
	FER-MAS®	FSZ210-180200185-s	7077618040	BUSHING	Dump Cylinder (Barrel End)
	FER-MAS®	FSZ210-180200187-s	4277011790	BUSHING	Lift Cylinder (Barrel End)
	TEF-MET®	TFZ 16080	7075291350 / 7075291351	BUSHING	Lift Cylinder (Barrel Inner Part)



	Parts Compatible With :				Model :
	KOMATSU®				D66-S Track Loader
	Bearing Type	SBS PN	Genuine PN	Part Name	Application
	TEF-MET®	TFZ 10035	0717701035	BUSHING	Bucket Dump Cylinder (Barrel Inner Part)



	Parts Compatible With :				Model :
	KOMATSU®				BR580JG/BR380JG Crushers
	Bearing Type	SBS PN	Genuine PN	Part Name	Application
	FER-MAS®	FSZ210-140160164-s	21N7012170	BUSHING	Crusher Toggle Link
	FER-MAS®	FSZ201-115135132-s	2097253170	BUSHING	Crusher Setting

SPB: Spherical Plain Bearings | FER-MAS®: Hardened Steel Bush | FER-MAN®: Hardened Manganese Steel | TEF-MET®: PTFE Coated Bush
 BRO-MAS®: High Strength Bronze Bush | BIV-MET®: Bimetal Steel/Bronze | COM-KU®/M: Fiberglass Composite

Disclaimer



All brand names, model names or marks are owned by their respective manufacturers. SBS – Singa Bearings Solutions Pte Ltd has no affiliation with the original equipment manufacturer. These terms are used for identification purposes only and are not intended to indicate affiliation with or approval by the OEM. All parts are manufactured by, for and warranted by SBS – Singa Bearings Solutions Pte Ltd and are not manufactured by, purchased from or warranted by the original equipment manufacturer.

	Parts Compatible With :				Model :
	KOMATSU®				JV80/100/130 Road/Vibratory Roller
	Bearing Type	SBS PN	Genuine PN	Part Name	Application
	SPB	GE259-8013070-sa	5696322880	BUSHING	Front Frame Center Pin

	Parts Compatible With :				Model :
	KOMATSU®				WS23S Wheel Scraper
	Bearing Type	SBS PN	Genuine PN	Part Name	Application
	TEF-MET®	TFZ 10035	0717701035	BUSHING	Ejector Cylinder (Barrel Inner Part)



	Parts Compatible With :				Model :
	LE TOURNEAU®				L2350 Wheel Loader
	Bearing Type	SBS PN	Genuine PN	Part Name	Application
	SPB	GE259-215323161-si	-	BUSHING	Boom Cylinder



	Parts Compatible With :				Model :
	LIEBHERR®				R954 Excavator
	Bearing Type	SBS PN	Genuine PN	Part Name	Application
	FER-MAN®	FNZ246-140150105-s	-	BUSHING	Boom Cylinder



	Parts Compatible With :				Model :
	LIEBHERR®				R996 Excavator
	Bearing Type	SBS PN	Genuine PN	Part Name	Application
	FER-MAN®	FNZ246-250280288	11079255	BUSHING	Boom Cylinder

SPB: Spherical Plain Bearings | FER-MAS®: Hardened Steel Bush | FER-MAN®: Hardened Manganese Steel | TEF-MET®: PTFE Coated Bush
 BRO-MAS®: High Strength Bronze Bush | BIV-MET®: Bimetal Steel/Bronze | COM-KU®/M: Fiberglass Composite

Disclaimer
 All brand names, model names or marks are owned by their respective manufacturers. SBS – Singa Bearings Solutions Pte Ltd has no affiliation with the original equipment manufacturer. These terms are used for identification purposes only and are not intended to indicate affiliation with or approval by the OEM. All parts are manufactured by, for and warranted by SBS – Singa Bearings Solutions Pte Ltd and are not manufactured by, purchased from or warranted by the original equipment manufacturer.

	Parts Compatible With :				Model :
	LIEBHERR®				R9250
	Excavator				
	Bearing Type	SBS PN	Genuine PN	Part Name	Application
	FER-MAN®	FNZ246-160190188	11079119	BUSHING	Bucket Cylinder (Barrel End)
	FER-MAN®	FNZ246-200230208	11079121	BUSHING	Stick Cylinder
FER-MAN®	FNZ246-220250248	11078606	BUSHING	Boom Cylinder	

	Parts Compatible With :				Model :
	LIEBHERR®				R9350
	Excavator				
	Bearing Type	SBS PN	Genuine PN	Part Name	Application
	FER-MAN®	FNB246-160190100	11078593	BUSHING	Bucket Cylinder (Rod End)
	FER-MAN®	FNZ246-140170148	-	BUSHING	
	FER-MAN®	FNZ246-140170170	-	BUSHING	Clam Cylinder
	FER-MAN®	FNZ246-160190188	11079119	BUSHING	Bucket Cylinder (Barrel End)
	FER-MAN®	FNZ246-200230208	11079121	BUSHING	Stick Cylinder
FER-MAN®	FNZ246-220250248	11078606	BUSHING	Boom Cylinder	

	Parts Compatible With :				Model :
	LIEBHERR®				R9400
	Excavator				
	Bearing Type	SBS PN	Genuine PN	Part Name	Application
	FER-MAN®	FNB246-160190100	11078593	BUSHING	Bucket Cylinder (Rod End)
	FER-MAN®	FNZ246-160190188	11079119	BUSHING	Bucket Cylinder (Barrel End)
	FER-MAN®	FNZ246-200230208	11079121	BUSHING	Stick Cylinder
FER-MAN®	FNZ246-220250248	11078606	BUSHING	Boom Cylinder	

SPB: Spherical Plain Bearings | FER-MAS®: Hardened Steel Bush | FER-MAN®: Hardened Manganese Steel | TEF-MET®: PTFE Coated Bush
 BRO-MAS®: High Strength Bronze Bush | BIV-MET®: Bimetal Steel/Bronze | COM-KU®/M: Fiberglass Composite

Disclaimer

All brand names, model names or marks are owned by their respective manufacturers. SBS – Singa Bearings Solutions Pte Ltd has no affiliation with the original equipment manufacturer. These terms are used for identification purposes only and are not intended to indicate affiliation with or approval by the OEM. All parts are manufactured by, for and warranted by SBS – Singa Bearings Solutions Pte Ltd and are not manufactured by, purchased from or warranted by the original equipment manufacturer.

TEF-MET®



wrapped composite dry sliding bearing, steel/PTFE, maintenance-free

TEF-MET®/B



wrapped composite sliding bearing, bronze/PTFE, maintenance-free

Wrapped composite bearing with PTFE sliding layer •
Maintenance-free • DIN 1494 / ISO 3547



	PROPERTIES	Excellent sliding and wear behaviour, for all types of movement, high load capacity.	
TEF-MET®	MATERIALS	TEF-MET®	TEF-MET®/B
Cylindrical bushing	Support material	Steel tin-plated	Bronze
TFZ	Intermediate layer	Sintered bronze	Sintered bronze
Flange bushing	Sliding layer	PTFE	PTFE
TFB	MATERIAL PROPERTIES		
Thrust washer	Specific load capacity static	≤ 250 [N/mm²]	
TFA	Specific load capacity dynamic	≤ 140 [N/mm²] at low sliding speeds	
Strips	Sliding speed	≤ 2.5 [m/s]	
TFS	Friction value	0,03 – 0,25 [μ]	
TEF-MET®/B	Temperature strain	-200 – +280 [°C]	
Cylindrical bushing	Max. p _v - value	1.8 [N/mm² x m/s] for a short time 3.6	
TFZ/B	TOLERANCE DETAILS		
Flange bushing	Housing Ø	H7	
TFB/B	Bushing Inner Ø after mounting	H9	
Thrust washer	Shaft tolerance	f7 or h8	
TFA/B	SHAFT MATERIAL	Steel, hardened or untempered, surface roughness R _a < 0.8 μm	
Strips	MOUNTING ADVICE		
TFS/B	Housing	Mounting chamfer, min. 1.5 mm x 15-45°	
	Shaft	Mounting chamfer, 5 mm x 15°, edges rounded	
	Force fitting mandrel	Application of an adequate force fitting mandrel is advisable. Grease lubrication of the outer surface may be necessary when mounting.	
	Glueing	Adhesive should not contact the sliding surface.	
	MAINTENANCE	TEF-MET® is a dry sliding bearing with a PTFE sliding layer. Lubrication is therefore not necessary, but basically possible!	

We produce all special designs at short notice! Cylindrical and flange bushings, thrust washer, strips are standard fabrication. Punchings and moldings are produced on customer's requirement.

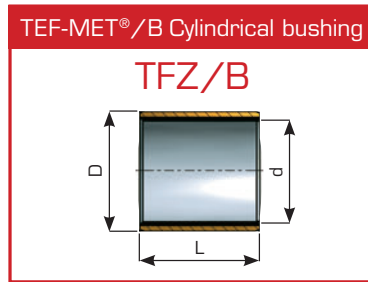
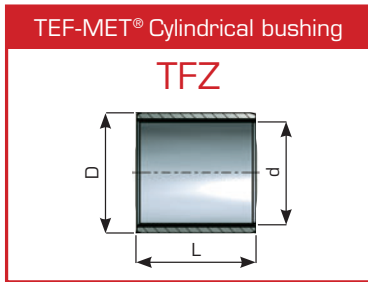

	L	03	04	06	08	10	12	15	20	25	30	35	40	50
d	D													
03	4.5	0303	0304											
04	5.5		0404	0406										
06	08		0604	0606	0608	0610								
07	09			0706	0708	0710		0715						
08	10			0806	0808	0810	0812	0815						
10	12			1006	1008	1010	1012	1015	1020					
12	14			1206	1208	1210	1212	1215	1220	1225				
13	15					1310	1312	1315						
14	16					1410	1412	1415	1420	1425				
15	17				1508	1510	1512	1515	1520	1525				
16	18				1608	1610	1612	1615	1620	1625				
17	19				1708	1710	1712	1715	1720	1725				
18	20				1808	1810	1812	1815	1820	1825	1830			
20	22					2010A	2012A	2015A	2020A	2025A	2030A	2035A	2040A	
20	23				2008B	2010B	2012B	2015B	2020B	2025B	2030B	2035B	2040B	
22	25				2208	2210	2212	2215	2220	2225	2230	2235	2240	2250
24	27					2410A	2412A	2415A	2420A	2425A	2430A	2435A	2440A	2450A
24	28					2410B	2412B	2415B	2420B	2425B	2430B	2435B	2440B	2450B
25	28					2510	2512	2515	2520	2525	2530	2535	2540	2550
26	30					2610	2612	2615	2620	2625	2630	2635	2640	2650
28	32					2810	2812	2815	2820	2825	2830	2835	2840	2850
30	34					3010	3012	3015	3020	3025	3030	3035	3040	3050
32	36					3210	3212	3215	3220	3225	3230	3235	3240	3250
35	39					3510	3512	3515	3520	3525	3530	3535	3540	3550

	L	12	15	20	25	30	35	40	50	60	70	80	90	100
d	D													
38	42	3812	3815	3820	3825	3830	3835	3840	3850	3860				
40	44	4012	4015	4020	4025	4030	4035	4040	4050	4060				
42	46	4212	4215	4220	4225	4230	4235	4240	4250	4260				
45	50		4515	4520	4525	4530	4535	4540	4550	4560				
50	55		5015	5020	5025	5030	5035	5040	5050	5060	5070			
55	60		5515	5520	5525	5530	5535	5540	5550	5560	5570			
60	65		6015	6020	6025	6030	6035	6040	6050	6060	6070	6080	6090	
65	70		6515	6520	6525	6530	6535	6540	6550	6560	6570	6580	6590	
70	75			7020		7030		7040	7050	7060	7070	7080	7090	
75	80			7520		7530		7540	7550	7560	7570	7580	7590	
80	85					8030		8040	8050	8060	8070	8080	8090	80100
85	90					8530		8540	8550	8560	8570	8580	8590	85100
90	95					9030		9040	9050	9060	9070	9080	9090	90100
95	100					9530		9540	9550	9560	9570	9580	9590	95100
100	105					10030		10040	10050	10060	10070	10080	10090	100100

	L	50	60	70	80	90	100	110	115	120	130	140	150
d	D												
105	110	10550	10560	10570	10580	10590	105100		105115				
110	115	11050	11060	11070	11080	11090	110100		110115				
115	120	11550	11560	11570	11580	11590	115100		115115				
120	125	12050	12060	12070	12080	12090	120100			120120			
125	130	12550	12560	12570	12580	12590	125100		125115				
130	135		13060	13070	13080	13090	130100			130120			
135	140		13560	13570	13580	13590	135100			135120			
140	145		14060	14070	14080	14090	140100						
150	155		15060	15070	15080	15090	150100						
160	165		16060	16070	16080	16090	160100	160110		160120	160130	160140	160150
170	175		17060	17070	17080	17090	170100	170110		170120	170130	170140	170150
180	185		18060	18070	18080	18090	180100	180110		180120	180130	180140	180150
200	205		20060	20070	20080	20090	200100	200110		200120	200130	200140	200150
220	225		22060	22070	22080	22090	220100	220110		220120	220130	220140	220150
250	255		25060	25070	25080	25090	250100	250110		250120	250130	250140	250150
300	305		30060	30070	30080	30090	300100	300110		300120	300130	300140	300150

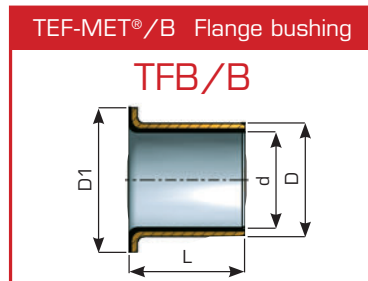
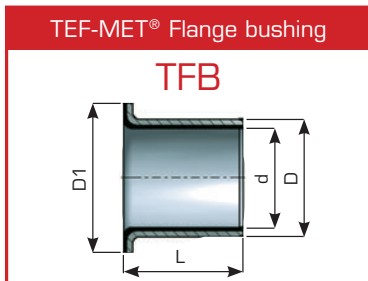

d	D	D1	L	04	05	05,5	06	07	07,5	08	09	09,5	10
d	D	D1	Flange thickness										
03	4.5	7	0.75	0304									
04	5.5	9	0.75	0404									0410
05	07	10	1		0505		0506						
06	08	12	1	0604			0606	0607		0608			0610
08	10	15	1			0805,5			0807,5			0809,5	0810
10	12	18	1					1007			1009		1010
12	14	20	1				1206	1207			1209		1210
14	16	22	1										1410
15	17	23	1								1509		1510

d	D	D1	L	11	11.5	12	15	16	16.5	17	20	21.5	22
d	D	D1	Flange thickness										
10	12	18	1	1011		1012	1015			1017			
12	14	20	1			1212	1215			1217	1220		
13	15	21	1				1315				1320		
14	16	22	1				1412	1415		1417	1420		
15	17	23	1	1511			1512	1515		1517	1520		
16	18	24	1				1612	1615		1617			1622
18	20	26	1				1812	1815		1817			1822
20	23	30	1.5		2011,5		2015		2016.5		2020	2021.5	
22	25	33	1.5		2211.5				2216.5			2221.5	
25	28	35	1.5		2511.5	2512			2516.5			2521.5	
30	34	42	2					3016			3020		3022
32	36	46	2										3222
35	39	47	2					3516			3520		3522
40	44	53	2								4020		
45	50	58	2.5					4516					4522
50	55	65	2.5					5016			5020		5022

			L	25	26	26.5	30	40	50	60	70	80	100
d	D	D1	Flange thickness										
20	23	30	1.5	2025		2026.5							
22	25	33	1.5			2226.5							
25	28	35	1.5			2526.5							
30	34	42	2		3026		3030	3040					
32	36	46	2				3230						
35	39	47	2		3526		3530	3540	3550				
40	44	53	2		4026		4030	4040					
45	50	58	2.5		4526		4530	4540					
50	55	65	2.5	5025	5026		5030	5040	5050	5060			
55	60	70	2.5					5540					
60	65	75	2.5				6030	6040	6050	6060			
70	75	85	2.5				7030	7040	7050		7070		
75	80	90	2.5							7560		7580	
80	85	95	2.5					8040	8050	8060		8080	80100
85	90	100	2.5										85100
90	95	110	2.5					9040		9060		9090	90100
100	105	120	2.5							10060	10070		100100
110	115	130	2.5							11060			
120	125	150	2.5							12060	12070		120100
130	135	155	2.5										130100
140	145	165	2.5							14060		14080	
160	165	190	2.5									16080	160100
220	225	235	2.5										220100
250	255	290	2.5										250100

TEF-MET® Thrust washer

TFA

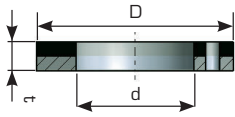

TEF-MET®/B Thrust washer

TFA/B

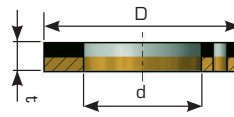

Art. Nr.	d	D	t
TFA 10/1	10	20	1.5
TFA 12/1	12	24	1.5
TFA 14/1	14	26	1.5
TFA 16/1	16	30	1.5
TFA 18/1	18	32	1.5
TFA 20/1	20	36	1.5
TFA 22/1	22	38	1.5
TFA 24/1	24	42	1.5
TFA 26/1	26	44	1.5
TFA 28/1	28	48	1.5
TFA 32/1	32	54	1.5
TFA 38/1	38	62	1.5
TFA 42/1	42	66	1.5
TFA 48/2	48	74	2.0
TFA 52/2	52	78	2.0
TFA 62/2	62	90	2.0

Art. Nr.	d	D	t
TFA/B 10/1	10	20	1.5
TFA/B 12/1	12	24	1.5
TFA/B 14/1	14	26	1.5
TFA/B 16/1	16	30	1.5
TFA/B 18/1	18	32	1.5
TFA/B 20/1	20	36	1.5
TFA/B 22/1	22	38	1.5
TFA/B 24/1	24	42	1.5
TFA/B 26/1	26	44	1.5
TFA/B 28/1	28	48	1.5
TFA/B 32/1	32	54	1.5
TFA/B 38/1	38	62	1.5
TFA/B 42/1	42	66	1.5
TFA/B 48/2	48	74	2
TFA/B 52/2	52	78	2
TFA/B 62/2	62	90	2

TEF-MET® Strips

TFS

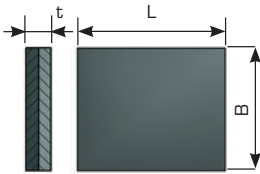

TEF-MET®/B Strips

TFS/B

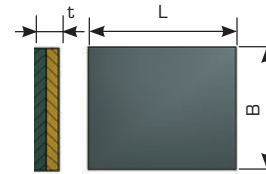

Art. Nr.	B	L	t
TFS 10240	245	500	1.0
TFS 15240	245	500	1.5
TFS 20240	245	500	2.0
TFS 25240	245	500	2.5
TFS 30240	245	500	3.0

Art. Nr.	B	L	t
TFS/B 10240	245	500	1.0
TFS/B 15240	245	500	1.5
TFS/B 20240	245	500	2.0
TFS/B 25240	245	500	2.5
TFS/B 30240	245	500	3.0

POM-MET®



wrapped composite sliding bearing, steel/acetal resin (POM),
lubrication pockets, low-maintenance

Wrapped composite sliding bearing, steel / POM, with lubrication pockets •
Low-maintenance • DIN 1494 / ISO 3547

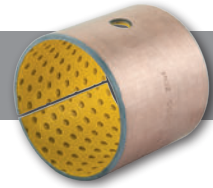

<p>POM-MET®</p> <p>Cylindrical bushing</p> <p>POZ</p> <p>Thrust washer</p> <p>POA</p> <p>Strips</p> <p>POS</p>	<p>PROPERTIES</p> <p>Suitable for grease or oil lubrication and all kinds of movements, good load capacity, robust and insensible to dirt.</p>
	<p>MATERIALS</p> <p>Support material: Steel copper plated / tinplated</p> <p>Intermediate layer: Sintered bronze</p> <p>Sliding layer: Acetal resin / POM</p>
	<p>MATERIAL PROPERTIES</p> <p>Specific load capacity static: ≤ 250 [N/mm²]</p> <p>Specific load capacity dynamic: ≤ 140 [N/mm²] at low sliding speeds</p> <p>Sliding speed: ≤ 2.5 [m/s]</p> <p>Friction value: 0.04 – 0.12 [μ] depending on lubrication</p> <p>Temperature strain: -40 – +130 [°C] for a short time up to +130 °C</p> <p>Max. p_v - value: 2.8 [N/mm² x m/s]</p>
	<p>TOLERANCE DETAILS</p> <p>Housing \varnothing: H7</p> <p>Bushing Inner \varnothing after mounting: D9</p> <p>Shaft tolerance: h8</p>
	<p>SHAFT MATERIAL</p> <p>Steel, hardened or untempered, surface roughness $R_a < 4 \mu\text{m}$</p>
	<p>MOUNTING ADVICE</p> <p>Housing: Mounting chamfer, min. 1.5 mm x 15-45°</p> <p>Shaft: Mounting chamfer, 5 mm x 15°, edges rounded</p> <p>Force fitting mandrel: Application of an adequate force fitting mandrel is advisable. Grease lubrication of the outer surface may be necessary when mounting.</p> <p>Glueing: Adhesive should not contact the sliding surface.</p>
<p>MAINTENANCE</p> <p>POM-MET® is a low-maintenance composite bearing with a POM sliding layer. Primary lubrication is necessary. Oil or grease lubrication is possible. Because of lubrication pockets lubrication intervals are reduced to a minimum!</p>	

We produce all special designs at short notice! Additional lubrication slots or lubrication drills on demand! Cylindrical bushings, thrust washer and strips are standard fabrication.

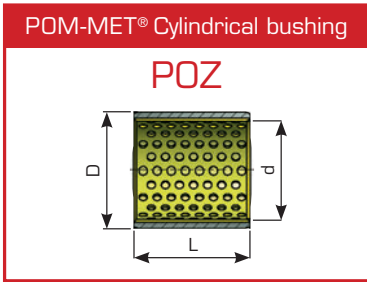

	L	05	06	08	10	12	15	20	25	30	35	40	50	60
d	D													
05	7	0505												
06	08		0606	0608	0610									
07	09				0710									
08	10	0805	0806	0808	0810	0812								
10	12		1006	1008	1010	1012	1015	1020						
12	14			1208	1210	1212	1215	1220	1225					
13	15				1310									
14	16				1410	1412	1415	1420	1425					
15	17				1510	1512	1515	1520	1525					
16	18			1608	1610	1612	1615	1620	1625					
17	19						1715	1720						
18	20				1810	1812	1815	1820	1825					
20	22				2010A		2015A	2020A						
20	23				2010B	2012B	2015B	2020B	2025B	2030B	2040B			
22	25						2215	2220	2225	2230	2240			
24	27					2412	2415	2420	2425	2430	2440	2450		
25	28				2510	2512	2515	2520	2525	2530	2540	2550		
26	30									2630	2640	2650		
28	31								2825A	2830A				
28	32						2815B	2820B	2825	2830	2840			
30	34				3010	3012	3015	3020	3025	3030	3040	3050		
32	36							3220	3225	3230	3240	3250		
35	39						3515	3520	3525	3530	3540	3550		
38	42						3815	3820	3825	3830	3835	3840	3850	3860
40	44				4010			4020	4025	4030	4035	4040	4050	4060
45	50							4520		4530	4535	4540	4550	4560

	L	10	15	20	25	30	35	40	50	60	70	80	90	100
d	D													
50	55		5015	5020	5025	5030	5035	5040	5050	5060	5070			
55	60	5510	5515	5520	5525	5530	5535	5540	5550	5560	5570			
60	65	6010	6015	6020	6025	6030	6035	6040	6050	6060	6070	6080	6090	
65	70		6515	6520	6525	6530	6535	6540	6550	6560	6570	6580		
70	75			7020	7025	7030	7035	7040	7050	7060	7070	7080	7090	
75	80			7520		7530		7540	7550	7560	7570	7580		
80	85					8030		8040	8050	8060	8070	8080		80100
85	90			8520		8530		8540	8550	8560	8570	8580	8590	85100
90	95					9030		9040	9050	9060	9070	9080	9090	90100
95	100					9530		9540	9550	9560	9570	9580	9590	95100
100	105					10030		10040	10050	10060	10070	10080	10090	100100
105	110							10540	10550	10560	10570	10580	10590	105100
110	115							11040	11050	11060	11070	11080	11090	110100
120	125			12020				12040	12050	12060	12070	12080	12090	120100

	L	50	60	70	80	90	100	110	115	120	130	140	150
d	D												
105	110							105110	105115				
110	115							110110	110115				
115	120	11550	11560	11570	11580	11590	115100	115110	115115				
120	125							120110	120115	120120		120140	
125	130	12550	12560	12070	12580	12590	125100	125110	125115	125120			
130	135	13050	13060	13070	13080	13090	130100	130110		130120		130140	
135	140	13550	13560	13570	13580	13590	135100	135110		135120			
140	145	14050	14060	14070	14080	14090	140100	140110		140120			
150	155	15050	15060	15070	15080	15090	150100	150110		150120			150150
160	165	16050	16060	16070	16080	16090	160100	160110		160120	160130	160140	160150
170	175	17050	17060	17070	17080	17090	170100	170110		170120	170130	170140	170150
180	185	18050	18060	18070	18080	18090	180100	180110		180120	180130	180140	180150
200	205	20050	20060	20070	20080	20090	200100	200110		200120	200130	200140	200150
220	225	22050	22060	22070	22080	22090	220100	220110		220120	220130	220140	220150
250	255		25060	25070	25080	25090	250100	250110		250120	250130	250140	250150
300	305		30060	30070	30080	30090	300100	300110		300120	300130	300140	300150

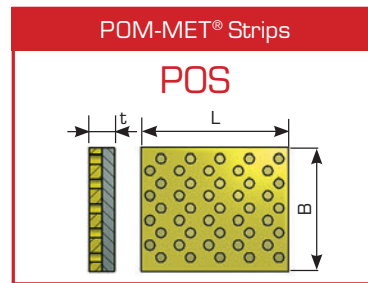
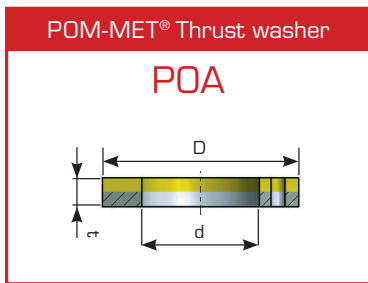

Art. Nr.	d	D	t
POA 10/1	10	20	1.5
POA 12/1	12	24	1.5
POA 14/1	14	26	1.5
POA 16/1	16	30	1.5
POA 18/1	18	32	1.5
POA 20/1	20	36	1.5
POA 22/1	22	38	1.5
POA 24/1	24	42	1.5
POA 26/1	26	44	1.5
POA 28/1	28	48	1.5
POA 32/1	32	54	1.5
POA 38/1	38	62	1.5
POA 42/1	42	66	1.5
POA 48/2	48	74	2
POA 52/2	52	78	2
POA 62/2	62	90	2

Art. Nr.	B	L	t
POS 10240	245	500	1.0
POS 15240	245	500	1.5
POS 20240	245	500	2.0
POS 25240	245	500	2.5
POS 30240	245	500	3.0

LUB-MET®



solid bronze sliding bearing, solid lubricant, maintenance-free

Solid bronze sliding bearing with solid lubricant inserts •
Maintenance-free



LUB - MET®	PROPERTIES		For high operational demands (also impact load), oscillating movements, wear-resistant, unsusceptible to dirt, corrosion resistant, long life capability. For more details, see Bearing properties (page 8).
Cylindrical bushing	MATERIAL PROPERTIES		Standard material CuZn25Al5 / ASTM C86300. For additional metal alloys, see LUB-MET® material list (page 8).
LMZ	SOLID LUBRICANTS		Our solid lubricants are high density compounds of graphite, PTFE and metals. Lubricants are oriented to motion direction. Direction to be specified with order.
Flange bushing	SL 1		Application for temperature up to 350°C , NOT for water and vapour
LMB	SL 4		Use for temp. up to 80°C. Designed for use in water and humidity. Very low coefficient of friction
Thrust washer	TOLERANCE DETAILS		
LMA	Housing Ø	H7	
Strips	Bushing Inner Ø after mounting	Standard tolerances: r6/E7	Different tolerances on customer request.
LMS	Shaft tolerance	f7 / h6	
	SHAFT MATERIAL		The hardness difference to the bearing should be at least 100HB, preferably hardened and ground to size. Surface roughness Ra 0.2 – 0.8 µm
	MOUNTING ADVICE		
	Housing	Mounting chamfer; min. 1,5 mm x 15-45°	
	Shaft	Mounting chamfer; 5 mm x 15°, edges rounded	
	Force fitting mandrel	Using a force fitting mandrel is advisable. Grease lubrication of outer surface may be necessary before assembly.	
	Freeze fitting	For diameter > 130mm, the use of dry ice is advisable	
	MAINTENANCE		LUB-MET® is a maintenance-free sliding bearing, but primary lubrication is necessary! Therefore, an ageing resistant lithium-stiffened grease should be used.

We produce all special designs at short notice! Custom sizes are manufactured in a short time!

MATERIAL LIST

Material description				Analysis	Physical properties					Application
DIN Alloy No.	ASTM Alloy No.	Scandinavian Alloy No.	British Alloy No.	Chemical Composition	Yield Strength	Tensile Strength	Elongation	E-module	Hardness	
				%	N/mm ²	N/mm ²	%	x 10 ³	HB	
CuSn7ZnPb ₁ CuSn7ZnPb ₂ CuSn7ZnPb ₃	C932 00	JM1	1400 LG2	Cu 81-85 Sn 5-6 Zn 3-5 Pb 5-7 Ni 2 max Sb 3,3 max	120 130 120	240 270 270	15 13 16	106 106 106	65 75 70	Medium-hard bearing alloy Good anti-friction properties Seawater resistant Applicable for light edgeloads
CuSn12Pb ₁ CuSn12Pb ₂ CuSn12Pb ₃	C925 00	JM3	1400 PB2	Cu 84-88 Sn 11-13 Pb 1-2 Ni 2 max Sb 0,2 max P 0,2 max	140 150 140	260 280 280	10 5 7	112 112 112	80 90 85	Material for high loads Seawater resistant
CuAl10Ni ₁ CuAl10Ni ₂ CuAl10Ni ₃	C955 00	JM7	1400 AB2	Cu 75 min Al 8,5-11 Ni 2-8,5 Fe 3,5-5,5 Mn 3,3 max	270 300 300	600 700 800	12 13 13	122 122 122	140 160 160	Hard Ni-Al bronze Very high strength Excellent wear resistance Corrosion-resistant Seawater resistant High temperature strength
CuZn25Al5 ₁ CuZn25Al5 ₂ CuZn25Al5 ₃	C863 00	JM18		Cu 60-67 Al 3-7 Fe 1,5-4 Mn 2,5-5 Zn balance Ni 3 max	450 480 480	750 750 750	8 8 5	115 115 115	200 220 220	Water resistant High strength bearing alloy High fatigue resistance Not applicable for seawater applications

₁ Sand casting ₂ Centrifugal casting ₃ Continuous casting

BEARING PROPERTIES *

Bronze Material	Solid Lubricant	p static (N/mm ²)	p dynamic (N/mm ²)	Friction dry	Friction wet	v (m/s) max.	max p _v value N/mm ² x m/s	Temp. °C max.	Shaft Hardness HB (min)	Shaft Finish R _a (µm)
CuSn7ZnPb	SL 4 SL 1	80 80	40 30	0.11 - 0.13 0.12 - 0.14	0.07 - 0.12 Not available	0.4 0.5	1.2 1.0	80 250	180	0.2 - 0.8
CuSn12PB	SL 4 SL 1	100 100	70 25	0.11 - 0.13 0.12 - 0.14	0.07 - 0.12 Not available	0.4 0.15	2.0 1.6	80 250	180	0.2 - 0.8
CuAl10Ni	SL 4 SL 1	150 150	90 80	0.13 - 0.15 0.14 - 0.16	0.07 - 0.12 Not available	0.4 0.4	1.5 1.5	80 350	300	0.2 - 0.8
CuZn25Al5	SL 4 SL 1	150 150	100 90	0.13 - 0.15 0.14 - 0.16	0.07 - 0.12 Not available	0.4 0.15	1.5 1.0	80 300	300	0.2 - 0.8

* The above stated bearings properties are valid for optimal operating conditions. Through changes of the application conditions as e.g. higher sliding speed or shaft roughness, these values are subject to change.

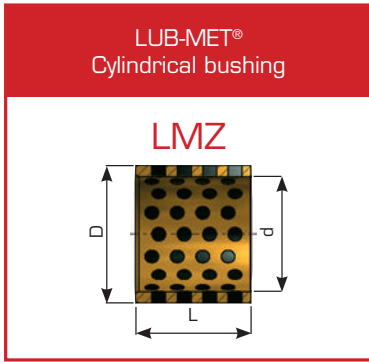

LM	Z	50	65	70
Type (LUB-MET®)	Geometry (Cylindrical bushing)	Inner diameter 50 mm (d)	Outer diameter 65 mm (D)	Length 70 mm (L)

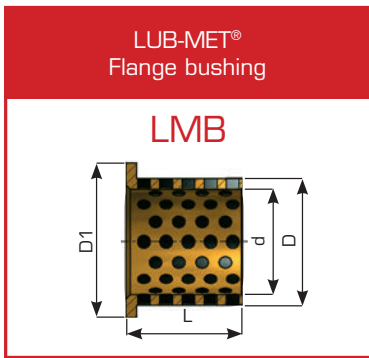

LM	B	50	65	70
Type (LUB-MET®)	Geometry (Flange bushing)	Inner diameter 50 mm (d)	Outer diameter 65 mm (D)	Length 70 mm (L)

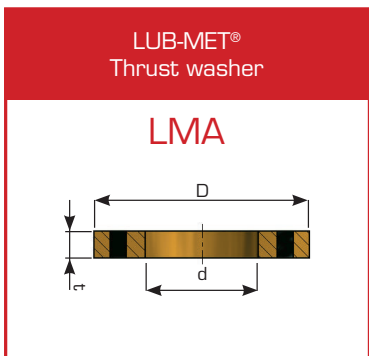

LM	A	30	60	05
Type (LUB-MET®)	Geometry (Thrust washer)	Inner diameter 30 mm (d)	Outer diameter 60 mm (D)	Thickness 5 mm (t)

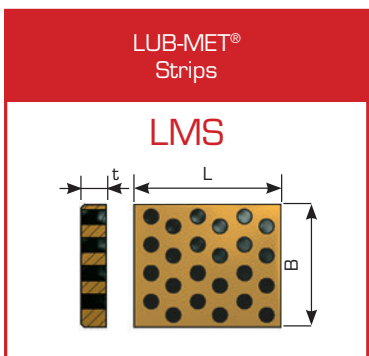

LM	S	30	70	10
Type (LUB-MET®)	Geometry (Strip)	Width 30 mm (B)	Length 70 mm (L)	Thickness 10 mm (t)

All sizes and measurements can be produced to customer's specification.

BRO-MAS®



solid turned bronze sliding bearing, heavy-maintenance

Solid turned bronze sliding bearing • DIN 1850 / ISO 4379 • Various alloys



BRO-MAS®
Cylindrical bushing
BSZ
Flange bushing
BSB
Thrust washer
BSA
Strips
BSS

PROPERTIES

Maintenance-bound sliding bearing, suitable for operation in contaminated environment, good corrosion resistance, unsusceptible to impact load.

MATERIALS

Standard material

Standard material CuSn12

MATERIAL PROPERTIES

Specific load capacity static	≤ 150 [N/mm ²]
Specific load capacity dynamic	≤ 60 [N/mm ²]
Sliding speed	< 10 [m/s] depends on lubrication - strain
Temperature strain	-40 - +150 [°C]

TOLERANCE DETAILS

Housing Ø	According to customer's preference.
Bushing Inner Ø after mounting	According to customer's preference.
Shaft tolerance	According to customer's preference.

SHAFT MATERIAL

Hardened steel, surface roughness $R_a < 0.8 \mu\text{m}$

MOUNTING ADVICE

Housing	Mounting chamfer, min. 1,5 mm x 15-45°
Shaft	Mounting chamfer, 5 mm x 15°, edges rounded
Freeze fitting	For diameter > 130mm, dry ice or liquid nitrogen can be used

MAINTENANCE

Oil or grease lubrication is necessary. Lubrication groove systems and greater clearance between shaft and bushing will reduce maintenance to a minimum.

DIN Alloy No.	ASTM Alloy No.	Scandinavian Alloy No.	British Alloy No.	Yield Strength	Tensile Strength	Elongation	Hardness
				N/mm ²	N/mm ²	%	HB
CuSn7ZnPb (RG7)	C93200	JM1	1400 LG 2	130	270	13	75
CuSn10	C90700	JM2	1400 PB1	140	290	13	80
CuSn12	C90800	JM3	1400 PB2	150	280	5	95
CuPb15Sn	C93800	JM4	1400, LB1	100	210	7	65
CuPb10Sn	C93700	JM5	1400, LB2	100	220	8	70
CuAl10Ni	C95500	JM7	1400 AB2	300	680	13	160
CuSn10Zn (RG10)	SAE 62	JM12	1400 G1-C (BC3)	140	260	7	80
CuZn25Al5	C86300	JM18		480	750	8	220
CuSn5ZnPb (RG 5)	C83600	SS5204	1400 LG2 (BC6)	90	250	13	65

We produce all special designs at short notice!

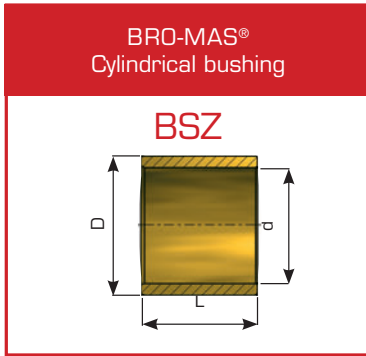

BS	Z	50	65	70
Type (BRO-MAS®)	Geometry (Cylindrical bushing)	Inner diameter 50 mm (d)	Outer diameter 65 mm (D)	Length 70 mm (L)

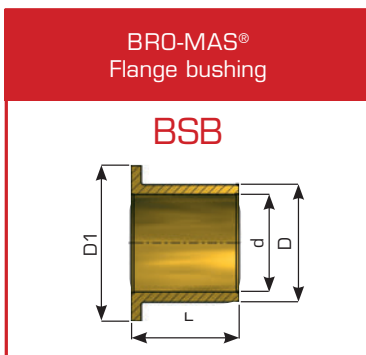

BS	B	50	65	70
Type (BRO-MAS®)	Geometry (Flange bushing)	Inner diameter 50 mm (d)	Outer diameter 65 mm (D)	Length 70 mm (L)

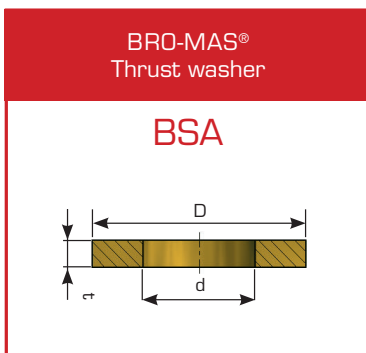

BS	A	30	60	05
Type (BRO-MAS®)	Geometry (Thrust washer)	Inner diameter 30 mm (d)	Outer diameter 60 mm (D)	Thickness 5 mm (t)

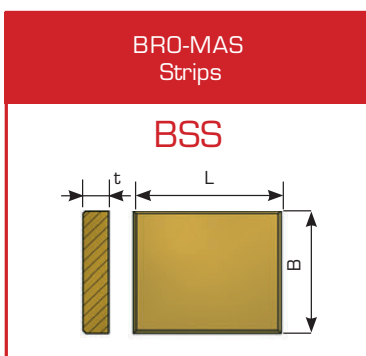

BS	S	30	70	10
Type (BRO-MAS®)	Geometry (Strip)	Width 30 mm (B)	Length 70 mm (L)	Thickness 10 mm (t)

All sizes and measurements can be produced to customer's specification.

FER-MAS®



turned steel sliding bearing, heavy-maintenance

Hardened and grinded steel sliding bearing •
Heavy maintenance



<p>FER-MAS®</p> <p>Cylindrical bushing</p> <p>FSZ</p>	<p>PROPERTIES</p> <p>Suitable for highest operational demands, unsusceptible, high durability. Narrow tolerances possible.</p>
	<p>MATERIALS</p> <p>20MnV6 hardened and grinded alternatively 100 Cr6 hardened and grinded</p>
	<p>MATERIAL PROPERTIES*</p> <p>Specific load capacity static ≤ 250 [N/mm²] Specific load capacity dynamic ≤ 150 [N/mm²] Sliding speed < 0.6 [m/s] Friction value 0.05 – 0.25 [μ] Temperature strain -100 – +250 [°C] Max. p_v - value 1.2 [N/mm² x m/s] Hardness 58 – 62 [HRC]</p>
	<p>TOLERANCE DETAILS</p> <p>Housing Ø H7 Shaft tolerance Specified by the customer.</p>
	<p>SHAFT MATERIAL</p> <p>Hardened steel (C45 recommended)</p>
	<p>MOUNTING ADVICE</p> <p>Housing Mounting chamfer, min. 1.5 mm x 15-45° Shaft Mounting chamfer, 5 mm x 15°, edges rounded Force fitting mandrel Application of an adequate force fitting mandrel is advisable. Grease lubrication of the outer surface may be necessary when mounting.</p>
	<p>MAINTENANCE</p> <p>Sufficient lubrication is necessary.</p>
<p>* The above stated material properties are valid for optimal operating conditions. Through changes of the application conditions e.g. higher sliding speed or strain, these values are subject to changes.</p>	

Special sizes or special lubrication slots are available on demand!

FER-MAS® Cylindrical bushing

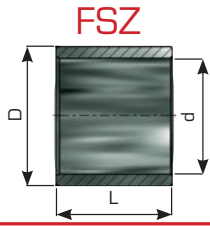

	L	20	25	30	35	40	45	50	55	60	65
d	D										
20	30	203020	203025	203030	203035	203040	203045	203050	203055	203060	203065
25	35			253530	253535	253540	253545	253550	253555	253560	253565
30	38			303830	303835	303840	303845	303850		303860	303865
30	40			304030	304035	304040	304045	304050	304055	304060	304065
35	45			354530	354535	354540	354545	354550	354555	354560	354565
40	50			405030	405035	405040	405045	405050	405055	405060	405065
45	55			455530	455535	455540	455545	455550	455555	455560	455565
50	60			506030	506035	506040	506045	506050	506055	506060	506065
55	65				556535	556540	556545	556550	556555	556560	556565
60	70				607035	607040	607045	607050	607055	607060	607065
65	75				657535	657540	657545	657550	657555	657560	657565
70	80				708035	708040	708045	708050	708055	708060	708065
75	85				758535	758540	758545	758550	758555	758560	758565
80	90					809040	809045	809050	809055	809060	809065
85	95					859540	859545	859550	859555	859560	
90	100						9010040	9010045	9010050	9010055	9010060

	L	70	75	80	85	90	95	100
d	D							
20	30							
25	35	253570	253575	253580	253585	253590	253595	2535100
30	38	303870		303880				
30	40	304070	304075	304080	304085	304090	304095	3040100
35	45	354570	354575	354580	354585	354590	354595	3545100
40	50	405070	405075	405080	405085	405090	405095	4050100
45	55	455570	455575	455580	455585	455590	455595	4555100
50	60	506070	506075	506080	506085	506090	506095	5060100
55	65	556570	556575	556580		556590		
60	70	607070		607080		607090		6070100
65	75	657570		657580		657590		6575100
70	80	708070		708080		708090		7080100
75	85	758570		758580		758590		7585100
80	90	809070		809080		809090	809095	8090100
85	95	859570		859580		859590		8595100
90	100	9010070		9010080		9010090		90100100

FER-MAS® Flange bushing

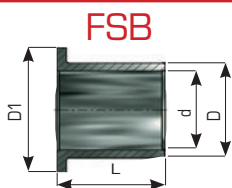

Flange bushings on customer's request.

FER-MET®



wrapped steel bearing, inner and outer tension bushing,
heavy-maintenance

Wrapped steel bearing • Inner and outer tension bushing •
DIN 1498 / 1499

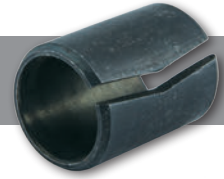

<p>FER-MET®</p> <p>Cylindrical bushing</p> <p>FMZ</p>	<p>PROPERTIES</p> <p>Extremely high load capacity, very wear-resistant, also suitable for heavy operational demands with impact load.</p>
	<p>MATERIALS</p> <p>Spring steel 55Si7, alternatively C67 or similar.</p>
	<p>GEOMETRY</p> <p>Form E Without chamfer at inner diameter Form F With chamfer at inner diameter Form G Straight slot Form P Arrowheaded slot Form S Slant slot</p>
	<p>TOLERANCE DETAILS</p> <p>Housing Ø H8 Bushing Inner Ø after mounting According to DIN 1498/1499 Shaft tolerance Specified by the customer.</p>
	<p>SHAFT MATERIAL</p> <p>Hardened steel (C45 recommended) Hardness +- 48 HRC</p>
<p>MOUNTING ADVICE</p> <p>Housing Mounting chamfer, min. 1.5 mm x 15-45° Shaft Mounting chamfer, 5 mm x 15°, edges rounded Force fitting mandrel Application of an adequate force fitting mandrel is advisable. Grease lubrication of the outer surface may be necessary when mounting.</p>	
<p>MAINTENANCE</p> <p>Sufficient lubrication is necessary.</p>	

FER-MET® is available only as cylindrical bushing! All special designs are available at short notice! Additional lubrication slots or lubrication drills on demand!

FER-MET® Cylindrical bushing

FMZ

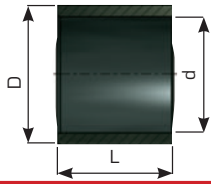

	L	10	12	14	16	18	20	22	25	28	36	40	45	50	60	70	80	100
d	D																	
10	14	101410		101414			101420											
10	16	101610		101614			101620											
12	16	121610		121614			121620											
12	18	121810		121814			121820											
14	18	141810		141814			141820											
14	20	142010		142014			142020											
16	20		162012		162016		162020											
16	22		162212		162216		162220											
18	24			182414			182420			182428								
20	26			202614		202618				202628								
20	28			202814		202818				202828								
22	28			222814			222820			222828								
25	32			253214			253220			253228		253240						
25	35			253514			253520			253528		253540						
28	35			283514			283520			283528		283540						
30	38					303818			303825		303836			303850				
30	40					304018			304025		304036			304050				
32	40					324018			324025		324036			324050				
36	45					364518			364525		364536			364550				
40	50						405020					405040		405060		405080		
45	55							455522				455540		455560		455580		
50	60								506025					506050		506070		5060100
55	65								556525					556550		556580		5565100
60	70								607025					607050		607070		6070100
65	75								657525					657550		657570		6575100
65	80								658025					658050		658070		6580100
70	85								708525					708550		708570		7085100
75	90								759025					759050		759070		7590100

	L	40	45	50	60	70	80	100	110	120	140	160	200
80	95	809540			809560			8095100		8095120			
85	100	8510040			8510060			85100100		85100120			
90	105		9010545		9010560			90105100		90105120			
95	110		9511045		9511060			95110100		95110120			
100	115		10011545		10011560			100115100		100115120			
105	120			10512050			10512080	105120100			105120140		
110	125			11012550			11012580	110125100			110125140		
115	130			11513050			11513080	115130100			115130140		
120	135			12013550			12013580	120135100			120135140		
125	140			12514050			12514080	125140100			125140140		
130	145			13014550			13014580	130145100			130145140		
135	150				13515060		13515080		135150110			135150160	
140	155				14015560		14015580		140155110			140155160	
145	160				14516060		14516080		145160110			145160160	
150	165					15016570		150165100				150165160	150165200
155	175					15517570		155175100				155175160	155175200
160	180					16018070		160180100				160180160	160180200
170	190						17019080		170190110			170190160	170190200
175	195						17519580		175195110			175195160	175195200
180	200						18020080		180200110			180200160	180200200

FER-MAN[®]246



low maintenance impact-resistance steel sliding bearing with very high surface hardness

FER-MAN[®]259

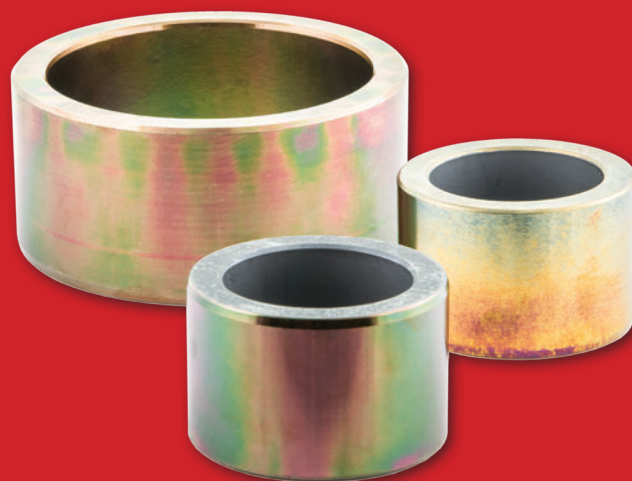

Maintenance-free steel bushing, impact resistant, high breaking strength, able to absorb shock loadings

Impact-resistant steel sliding bearing with very high surface hardness •
Heat and corrosion resistant • Low maintenance

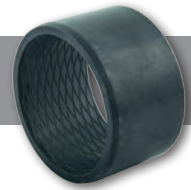

FER-MAN®246

Cylindrical bushing

FNZ

PROPERTIES

Applicable for higher loads, heat and corrosion resistant, non-seizing, restricted abrasion-resistance, long-life bushing. Typical applications: e.g. replacement of bronze bearings which need to be lubricated intensively for dirt repellence. Very good for applications for minimum or initial lubricated bearing points with mechanical or/and thermal stress. Areas of applications: Crane bearings assemblies, front and rocker bearings, lifting devices, mining machinery.

MATERIAL

Ferrous metal base, specially thermochemically treated, with lubrication patterns

MATERIAL PROPERTIES*

Specific load capacity static	≤ 400 [N/mm ²]
Specific load capacity dynamic	≤ 100 [N/mm ²]
Sliding speed	< 0.4 [m/s]
Friction value	0.12 – 0.16 [μ]
Temperature strain	< 400 [C°]
Surface hardness	550 – 650 [HV]
Core hardness	150 – 180 [HB]

TOLERANCE DETAILS

Housing Ø	H7
Shaft tolerance	Specified by the customer (recommended f7)

SHAFT MATERIAL

16 MnCr5 case-hardened or 42 CrMo4V inductive hardened

MOUNTING ADVICE

Housing	Mounting chamfer, min. 1.5 mm x 15-45°
Shaft	Mounting chamfer, 5 mm x 15°, edges rounded
Force fitting mandrel	Application of an adequate force fitting mandrel is advisable. Grease lubrication of the outer surface may be necessary when mounting.

MAINTENANCE

Initial and periodical lubrication is necessary.

* The above stated material properties are valid for optimal operating conditions. Through changes of the application conditions e.g. higher sliding speed or strain, these values are subject to change.

We produce all special designs at short notice! All sizes will be produced according to customer's request. Special dimensions possible.

Maintenance-free steel bushing • Impact resistant •
High breaking strength • Able to absorb shock loadings

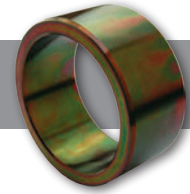

FER-MAN®259	PROPERTIES		Excellent resistance to abrasion in heavily contaminated applications. Even under high temperatures, adhesion does not occur. The material has a very high load carrying capacity and shows a great resistance to shock loads and impacts. Typical applications are in steel mills for ladles trunnion and grabs, but also in dredging for clamshells buckets and excavators.
Cylindrical bushing	MATERIAL		Fe-C-Mn base material, treated with thermochemical process under vacuum conditions
FNZ	MATERIAL PROPERTIES*		
Flange bushing	Specific load capacity static		≤ 460 [N/mm ²]
FNB	Specific load capacity dynamic		≤ 100 [N/mm ²]
Thrust washer	Sliding speed		< 0.2 [m/s]
FNA	Friction value		0.2 – 0.28 (lubricated 0.12) [μ]
Strips	Temperature strain		< 200 (temporary up to 400) [°C]
FNS	Surface hardness		up to 950 [HV] (depending on application demands)
	Core hardness		150 – 180 [HB]
	TOLERANCE DETAILS		
	Housing Ø		H7
	Shaft tolerance		Specified by the customer (recommended h9)
	SHAFT MATERIAL		42 CrMo4V induction hardened, 54-57 HRC, 2-4 mm deep
	MOUNTING ADVICE		
	Housing		Mounting chamfer, min. 1.5 mm x 15-45°
	Shaft tolerance		Mounting chamfer, 5 mm x 15°, edges rounded
	Force fitting mandrel		Application of an adequate force fitting mandrel is advisable. Grease lubrication of the outer surface may be necessary when mounting.
	MAINTENANCE		FER-MAN®259 exhibits very good wear behavior without lubrication. However, at higher p _v values (>0.2), lubrication is required.
	* The above stated material properties are valid for optimal operating conditions. Through changes of the application conditions e.g. higher sliding speed or strain, these values are subject to change.		

We produce all special designs at short notice! All sizes will be produced according to customer's request. Special dimensions possible.

FER-MAN®246
Cylindrical bushing

FNZ-246

FER-MAN®259
Cylindrical bushing

FNZ-259

FER-MAN®259
Flange bushing

FNB-259

FER-MAN®259
Thrust washer

FNA-259

FER-MAN®259
Strips

FNS-259

FN	Z-246	50	65	70
FN	Z-259	50	65	70
Type (FER-MAN®246) Type (FER-MAN®259)	Geometry (Cylindrical bushing)	Inner diameter FER-MAN®246 50 mm (d) FER-MAN®259 50 mm (d)	Outer diameter FER-MAN®246 65 mm (D) FER-MAN®259 65 mm (D)	Length FER-MAN®246 70 mm (L) FER-MAN®259 70 mm (L)

FN	B-259	50	65	70
Type (FER-MAN®259)	Geometry (Flange bushing)	Inner diameter FER-MAN®259 50 mm (d)	Outer diameter FER-MAN®259 65 mm (D)	Length FER-MAN®259 70 mm (L)

FN	A-259	30	60	05
Type (FER-MAN®259)	Geometry (Thrust washer)	Inner diameter FER-MAN®259 30 mm (d)	Outer diameter FER-MAN®259 60 mm (D)	Thickness FER-MAN®259 5 mm (t)

FN	S-259	30	70	10
Type (FER-MAN®259)	Geometry (Strip)	Width FER-MAN®259 30 mm (B)	Length FER-MAN®259 70 mm (L)	Thickness FER-MAN®259 10 mm (t)

COM-KU[®]/D



fibre-reinforced plastic composite sliding bearing, maintenance-free

Fibre-reinforced plastic composite sliding bearing •
Maintenance-free



	PROPERTIES	Good sliding properties, suitable for high load capacity (as well as impact and edge loads), good chemical resistance, long life span, good damping features. Recommended as replacement for lubricated bushings e.g. bronze. Maintenance-free.			
	MATERIAL	Compound plastic with friction modifiers, produced in a winding technique.			
COM-KU®/D	MATERIAL PROPERTIES*				
Cylindrical bushing		Unit	D400	D402	D406
KDZ	Compressive strength (Flatwise)	[N/mm ²]	>320	>300	>280
	Compressive strength (Edgewise)	[N/mm ²]	>100	>90	>90
	Safe Maximum Static Load	[N/mm ²]	<150	<140	<120
	Safe Maximum Dynamic Load	[N/mm ²]	<60	<60	<50
	Flexural Strength	[N/mm ²]	>80	>70	>70
Flange bushing	Shear strength	[N/mm ²]	>90	>80	>80
	Tensile strength	[N/mm ²]	>65	>60	>60
KDB	Tensile Modulus	[N/mm ²]	3200	3200	3200
	Coefficient of friction (dry)		0.13 – 0.15	0.10 – 0.12	0.06 – 0.09
	Coefficient of friction (lubricated H ₂ O / Oil)	[N/mm ²]	0.02 – 0.04	0.02 – 0.04	0.01 – 0.03
	Hardness - Rockwell M		80	80	80
	Density	gms/cc	1.3	1.3	1.3
Thrust washer	Water Absorption (volumetric)	%	<0.1	<0.1	<0.1
	Short term temperature (min./max.)	°C	-70 / 100	-70 / 100	-70 / 100
KDA	Temperature range (long term)	°C	-30 to 75	-30 to 75	-30 to 75
	Colour		Dark grey	Yellow	Light grey
	Other material grades e.g. for high-temperature or extreme wear-resistance are available on request. Existing material grades can be fine-tuned to specific application requirements.				
	TOLERANCE DETAILS				
	Housing Ø	H7			
	Bushing Inner Ø after mounting**	Specified by the customer			
	MOUNTING ADVICE				
	Housing	Mounting chamfer, min. 1.5 mm x 15-45°			
	Shaft	Mounting chamfer, 5 mm x 15°, edges rounded			
	Force fitting mandrel	Application of an adequate force fitting mandrel is advisable			
	Freeze fitting	For diameter > 130mm, use of liquid nitrogen is preferred			
	MAINTENANCE				
		No maintenance required if shaft is corrosion resistant. Otherwise, periodical greasing of the shaft is advised.			
		COM-KU®/D is a maintenance-free composite sliding bearing.			
	* The above stated material properties are valid for optimal operating conditions. Through changes of the application conditions e.g. higher sliding speed or strain, these values are subject to change.				
	** Please note, that fitting dimensions and tolerances have to be "plastic-tailored" considering the larger expansion coefficient compared to metal sliding bearings. As a result, larger tolerance ranges and clearances can occur.				

We produce all special designs at short notice!

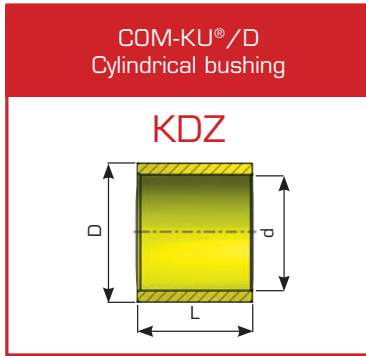

KD	Z	50	65	70
Type (COM-KU®/D)	Geometry (Cylindrical bushing)	Inner diameter 50 mm (d)	Outer diameter 65 mm (D)	Length 70 mm (L)

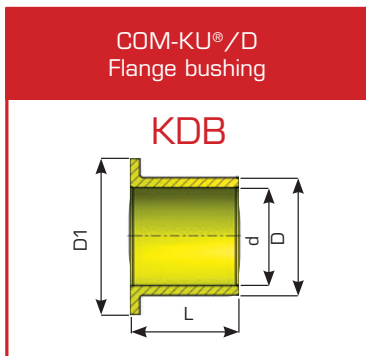

KD	B	50	65	70
Type (COM-KU®/D)	Geometry (Flange bushing)	Inner diameter 50 mm (d)	Outer diameter 65 mm (D)	Length 70 mm (L)

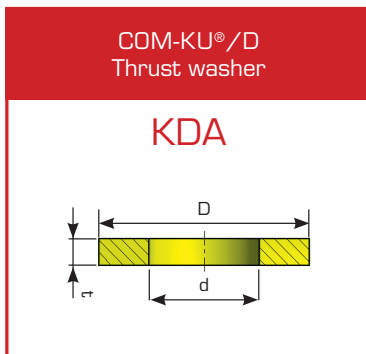

KD	A	30	60	05
Type (COM-KU®/D)	Geometry (Thrust washer)	Inner diameter 30 mm (d)	Outer diameter 60 mm (D)	Thickness 5 mm (t)

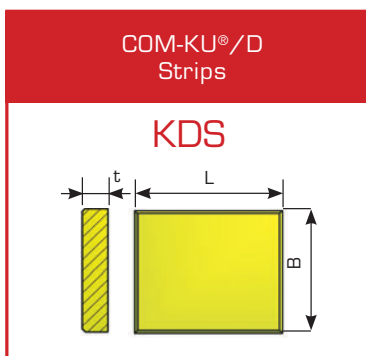

KD	S	30	70	10
Type (COM-KU®/D)	Geometry (Strip)	Width 30 mm (B)	Length 70 mm (L)	Thickness 10 mm (t)

All sizes and measurements can be produced to customer's specification.

BIV-MET®



wrapped composite sliding bearing, steel/bronze, lubrication pockets,
low-maintenance

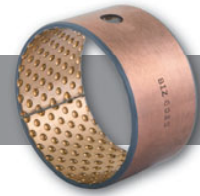

Wrapped composite sliding bearing steel / bronze with lubrication pockets
Low-maintenance • DIN 1494 / ISO 3547

BIV-MET® Cylindrical bushing BIZ Thrust washer BIA Strips BIS	PROPERTIES	For high load capacity and oscillating movements, as well as for rough operation and temperature load. Long-run lubrication because of lubricant storages.
	MATERIALS	
	Support material	Steel copper-plated / tin-plated
	Sliding layer	CuPb10Sn10
	MATERIAL PROPERTIES	
	Specific load capacity static	≤ 250 [N/mm ²]
	Specific load capacity dynamic	≤ 140 [N/mm ²]
	Sliding speed	≤ 2.5 [m/s] oil lubricated ≤ 5m/s
	Friction value	0.04 – 0.12 [μ] depending on lubrication
	Temperature strain	-40 – +250 [°C]
Max. p _v - value	2.8 [N/mm ² x m/s]	
Percentage contact area	> 75 [%]	
TOLERANCE DETAILS		
Housing Ø	H7	
Bushing Inner Ø after mounting	H9	
Shaft tolerance	f7	
SHAFT MATERIAL	Steel, hardened or untempered, surface roughness R _a < 0.8 μm	
MOUNTING ADVICE		
Housing	Mounting chamfer, min. 1.5 mm x 15-45°	
Shaft	Mounting chamfer, 5 mm x 15°, edges rounded	
Force fitting mandrel	Application of an adequate force fitting mandrel is advisable. Grease lubrication of the outer surface may be necessary when mounting.	
MAINTENANCE		
	BIV-MET® is a low-maintenance composite sliding bearing, but primary lubrication is necessary. Oil or grease lubrication is possible. Due to lubrication pockets, lubrication is reduced to a minimum.	

We produce all special designs at short notice! Flange bushings, punchings and moldings are produced on customer's requirement. Additional lubrication slots or lubrication drills are available on demand! Cylindrical bushings, thrust washer and strips are standard fabrication.

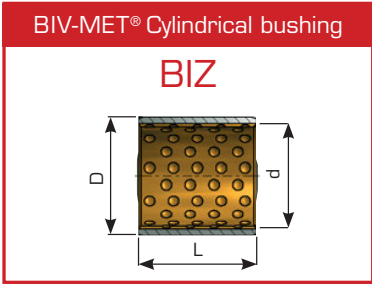

	L	10	15	20	25	30	40	50	60	80	90	100
d	D											
10	12	1010	1015	1020								
12	14	1210	1215	1220								
14	16	1410	1415	1420								
15	17	1510	1515	1520								
16	18	1610	1615	1620								
18	20	1810	1815	1820	1825							
20	23	2010	2015	2020	2025							
22	25	2210	2215	2220	2225							
24	27	2410	2415	2420		2430						
25	28		2515	2520	2525	2530						
26	30		2615	2620	2625	2630						
28	32		2815	2820	2825	2830	2840					
30	34		3015	3020	3025	3030	3040					
32	36		3215	3220	3225	3230	3240					
35	39			3520	3525	3530	3540	3550				
38	42			3820	3825	3830	3840	3850				
40	44			4020	4025	4030	4040	4050				
45	50			4520	4525	4530	4540	4550				
50	55					5030	5040	5050	5060			
55	60					5530	5540	5550	5560			
60	65					6030		6050	6060			
65	70					6530	6540	6550	6560			
70	75					7030	7040	7050	7060	7080		
75	80					7530	7540	7550	7560			
80	85						8040	8050	8060	8080		
85	90						8540	8550	8560	8580		
90	95						9040	9050	9060	9080		
95	100							9550	9560	9580	9590	
100	105							10050	10060	10080	10090	
105	110							10550	10560	10580		
110	115							11050	11060	11080		
115	120							11550	11560	11580		
120	125							12050	12060	12080		
125	130							12550	12560	12580		125100
130	135								13060	13080		130100
135	140								13560	13580		135100
140	145								14060	14080		140100
150	155								15060	15080	15090	
160	165								16060	16080		160100
170	175								17060	17080		170100
175	180								17560	17580		175100

BIV-MET® Thrust washer

BIA

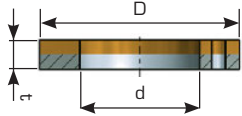

Art. Nr.	d	D	t
BIA 10/1	10	20	1.5
BIA 12/1	12	24	1.5
BIA 14/1	14	26	1.5
BIA 16/1	16	30	1.5
BIA 18/1	18	32	1.5
BIA 20/1	20	36	1.5
BIA 22/1	22	38	1.5
BIA 24/1	24	42	1.5
BIA 26/1	26	44	1.5
BIA 28/1	28	48	1.5
BIA 32/1	32	54	1.5
BIA 38/1	38	62	1.5
BIA 42/1	42	66	1.5
BIA 48/2	48	74	2
BIA 52/2	52	78	2
BIA 62/2	62	90	2

BIV-MET® Strips

BIS

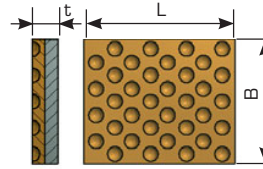

Art. Nr.	B	L	t
BIS 10240	245	500	1.0
BIS 15240	245	500	1.5
BIS 20240	245	500	2.0
BIS 25240	245	500	2.5
BIS 30240	245	500	3.0

SPHERICAL PLAIN BEARINGS & ROD ENDS



ball joint ends - spherical plain bearings
maintenance-free and heavy-maintenance

Spherical plain bearings

Requiring maintenance

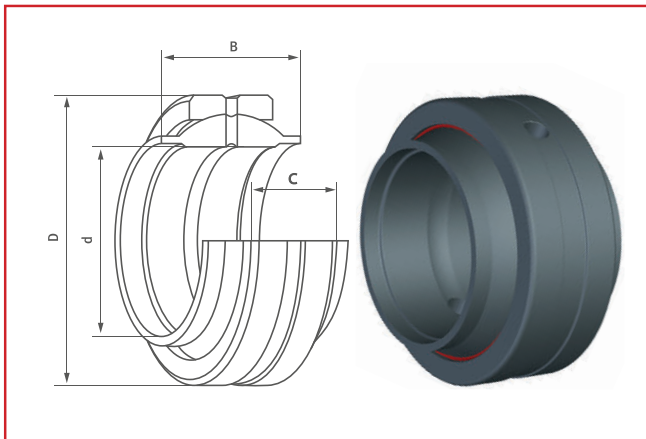

Spherical plain bearings, steel/steel, with wider inner ring

Art. Nr.		d	D	B	C	C	C ₀	Load ratings [kN]
GEG 12 ES	GE 12 LO	12	22	12	7	10.368	51.84	
GEG 16 ES	GE 16 LO	16	28	16	9	16.896	84.48	
GEG 20 ES	GE 20 LO	20	35	20	12	29	140	
GEG 25 ES	GE 25 LO	25	42	25	16	46	230	
GEG 30 ES	GE 30 LO	30	47	30	18	60	298	
GEG 32 ES	GE 32 LO	32	52	32	18	65.5	312	
GEG 35 ES	GE 35 LO	35	55	35	20	77	384	
GEG 40 ES	GE 40 LO	40	62	40	22	96	480	
GEG 45 ES	GE 45 LO	45	68	40	25	122	614	
GEG 50 ES	GE 50 LO	50	75	50	28	150	749	
GEG 60 ES	GE 60 LO	60	90	54	36	235	1171	
GEG 63 ES	GE 63 LO	63	95	63	36	244.8	1219.2	
GEG 70 ES	GE 70 LO	70	105	65	40	302	1498	
GEG 80 ES	GE 80 LO	80	120	80	45	384	1920	
GEG 90 ES	GE 90 LO	90	130	90	50	470.4	2352	
GEG 100 ES	GE 100 LO	100	150	100	55	585.6	2928	
GEG 110 ES	GE 110 LO	110	160	110	55	628.8	3120	
GEG 125 ES	GE 125 LO	125	180	125	70	912	4560	
GEG 160 ES	GE 160 LO	160	230	160	80	1315.2	6528	
GEG 200 ES	GE 200 LO	200	290	200	100	2035.2	10176	
GEG 250 ES	GE 250 LO	250	400	250	120	3408	17280	
GEG 320 ES	GE 320 LO	320	520	320	160	5856	29280	

Spherical plain bearings, steel/steel, with wider inner ring and sealing

Art. Nr.		d	D	B	C	C	C ₀	Load ratings [kN]
GEM 20 ES 2RS	GE 20 HO 2RS	20	35	24	12	29	140	
GEM 25 ES 2RS	GE 25 HO 2RS	25	42	29	16	46	230	
GEM 30 ES 2RS	GE 30 HO 2RS	30	47	30	18	60	298	
GEM 35 ES 2RS	GE 35 HO 2RS	35	55	35	20	77	384	
GEM 40 ES 2RS	GE 40 HO 2RS	40	62	38	22	96	480	
GEM 45 ES 2RS	GE 45 HO 2RS	45	68	40	25	122	614	
GEM 50 ES 2RS	GE 50 HO 2RS	50	75	43	28	150	749	
GEM 60 ES 2RS	GE 60 HO 2RS	60	90	54	36	235	1171	
GEM 70 ES 2RS	GE 70 HO 2RS	70	105	65	40	302	1498	
GEM 80 ES 2RS	GE 80 HO 2RS	80	120	74	45	384	1920	

Permissible working temperature: -60°C - +130°C (Applications up to +200°C without sealings and from 150°C with possible losses of length of life). Further restrictions through lubricant should be kept in mind.

Spherical plain bearings

Requiring maintenance

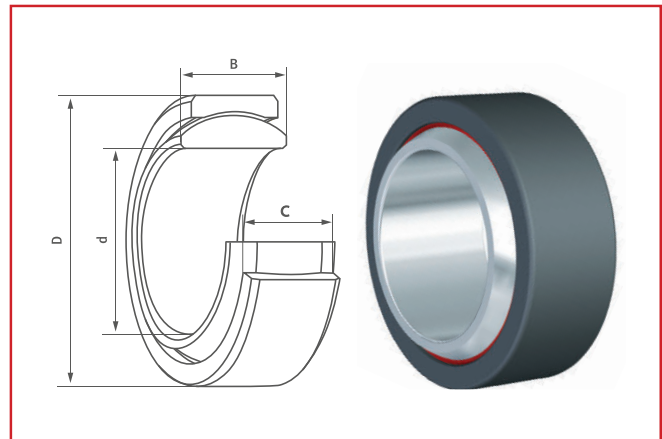

Spherical plain bearings, hard chrome plated/PTFE

Art. Nr.		d	D	B	C	C	C ₀	Load ratings [kN]
GE 6 UK	GE 6 C	6	14	6	4	3.5	8.6	
GE 8 UK	GE 8 C	8	16	8	5	5.6	14	
GE 10 UK	GE 10 C	10	19	9	6	8.3	21	
GE 12 UK	GE 12 C	12	22	10	7	10.9	27	
GE 15 UK	GE 15 C	15	26	12	9	17.3	43	
GE 17 UK	GE 17 C	17	30	14	10	21.5	54	
GE 20 UK	GE 20 C	20	35	16	12	30	75	
GE 25 UK	GE 25 C	25	42	20	16	49	122	
GE 30 UK	GE 30 C	30	47	22	18	63	159	

Spherical plain bearings, hard chrome plated/PTFE with sealing

Art. Nr.		d	D	B	C	C	C ₀	Load ratings [kN]
GE 20 UK 2RS	GE 20 TE 2RS	20	35	16	12	67.5	112	
GE 25 UK 2RS	GE 25 TE 2RS	25	42	20	16	127	212	
GE 30 UK 2RS	GE 30 TE 2RS	30	47	22	18	165	275	
GE 35 UK 2RS	GE 35 TE 2RS	35	55	25	20	210	350	
GE 40 UK 2RS	GE 40 TE 2RS	40	62	28	22	277	462	
GE 45 UK 2RS	GE 45 TE 2RS	45	68	32	25	360	600	
GE 50 UK 2RS	GE 50 TE 2RS	50	75	35	28	442	737	
GE 60 UK 2RS	GE 60 TE 2RS	60	90	44	36	690	1150	
GE 70 UK 2RS	GE 70 TE 2RS	70	105	49	40	885	1475	
GE 80 UK 2RS	GE 80 TE 2RS	80	120	55	45	1125	1875	
GE 90 UK 2RS	GE 90 TE 2RS	90	130	60	50	1380	2300	
GE 100 UK 2RS	GE 100 TE 2RS	100	150	70	55	1717	2862	
GE 110 UK 2RS	GE 110 TE 2RS	110	160	70	55	1845	3075	
GE 120 UK 2RS	GE 120 TE 2RS	120	180	85	70	2685	4475	
GE 140 UK 2RS	GE 140 TA 2RS	140	210	90	70	3015	5025	
GE 160 UK 2RS	GE 160 TA 2RS	160	230	105	80	3840	6400	
GE 180 UK 2RS	GE 180 TA 2RS	180	260	105	80	4320	7200	
GE 200 UK 2RS	GE 200 TA 2RS	200	290	130	100	6000	10000	
GE 220 UK 2RS	GE 220 TA 2RS	220	320	135	100	6600	11000	
GE 240 UK 2RS	GE 240 TA 2RS	240	340	140	100	7200	12000	
GE 260 UK 2RS	GE 260 TA 2RS	260	370	150	110	8550	14250	
GE 280 UK 2RS	GE 280 TA 2RS	280	400	155	120	10050	16750	
GE 300 UK 2RS	GE 300 TA 2RS	300	430	165	120	10080	18000	

Permissible working temperature: -50°C - +95°C (Applications up to +200°C with possible losses of length of life).

Rod ends Requiring maintenance

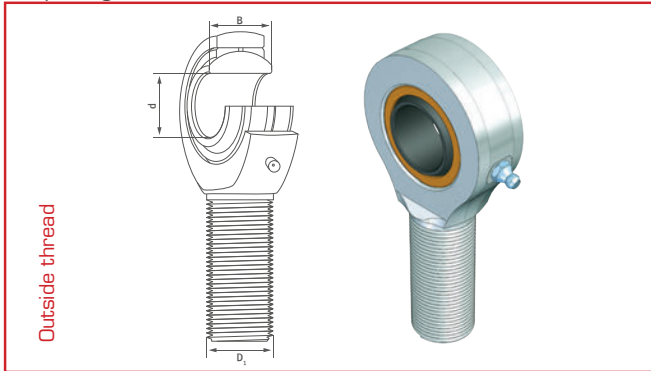

Rod end, steel / bronze with outside thread

Art. Nr.		d	B	D ₁
GAKFR 5 PB	(SAKAC 5 M)	5	8	M5
GAKFR 6 PB	(SAKAC 6 M)	6	9	M6
GAKFR 8 PB	(SAKAC 8 M)	8	12	M8
GAKFR 10 PB	(SAKAC 10 M)	10	14	M10
GAKFR 12 PB	(SAKAC 12 M)	12	16	M12
GAKFR 14 PB	(SAKAC 14 M)	14	19	M14
GAKFR 16 PB	(SAKAC 16 M)	16	21	M16
GAKFR 17 PB	(SAKAC 17 M)	17	22	M17
GAKFR 18 PB	(SAKAC 18 M)	18	23	M18 x 1,5
GAKFR 20 PB	(SAKAC 20 M)	20	25	M20 x 1,5
GAKFR 22 PB	(SAKAC 22 M)	22	28	M22 x 1,5
GAKFR 25 PB	(SAKAC 25 M)	25	31	M24 x 2
GAKFR 28 PB	(SAKAC 28 M)	28	35	M27 x 2
GAKFR 30 PB	(SAKAC 30 M)	30	37	M30 x 2

Rod ends Maintenance-bound

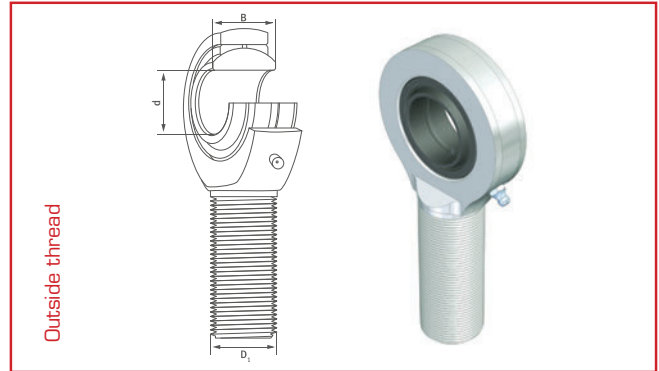

Rod end, steel / steel with outside thread

Art. Nr.		d	B	D ₁
GAR 6 DO	(SA 6 ES)	6	6	M6
GAR 8 DO	(SA 8 ES)	8	8	M8
GAR 10 DO	(SA 10 ES)	10	9	M10
GAR 12 DO	(SA 12 ES)	12	10	M12
GAR 15 DO	(SA 15 ES)	15	12	M14
GAR 17 DO	(SA 17 ES)	17	14	M16
GAR 20 DO	(SA 20 ES)	20	16	M20 x 1,5
GAR 25 DO	(SA 25 ES)	25	20	M24 x 2
GAR 30 DO	(SA 30 ES)	30	22	M30 x 2
GAR 35 DO	(SAA 35 ES)	35	25	M36 x 3
GAR 40 DO	(SAA 40 ES)	40	28	M39 x 3
GAR 45 DO	(SAA 45 ES)	45	32	M42 x 3
GAR 50 DO	(SAA 50 ES)	50	35	M45 x 3
GAR 60 DO	(SAA 60 ES)	60	44	M52 x 3
GAR 70 DO	(SAA 70 ES)	70	49	M56 x 4
GAR 80 DO	(SAA 80 ES)	80	55	M64 x 4

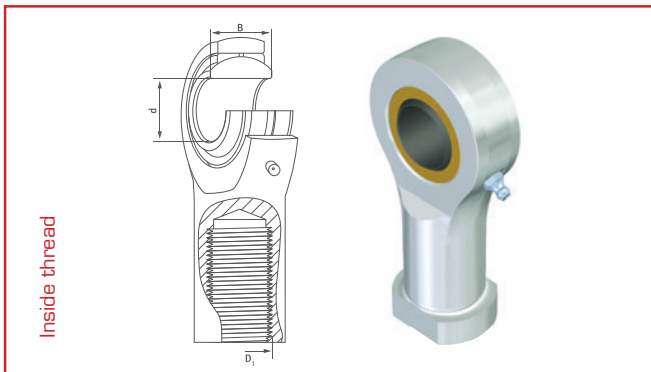

Rod end, steel / bronze with inside thread

Art. Nr.		d	B	D ₁
GIKFR 5 PB	(SIKAC 5 M)	5	8	M5
GIKFR 6 PB	(SIKAC 6 M)	6	9	M6
GIKFR 8 PB	(SIKAC 8 M)	8	12	M8
GIKFR 10 PB	(SIKAC 10 M)	10	14	M10
GIKFR 12 PB	(SIKAC 12 M)	12	16	M12
GIKFR 14 PB	(SIKAC 14 M)	14	19	M14
GIKFR 16 PB	(SIKAC 16 M)	16	21	M16
GIKFR 17 PB	(SIKAC 17 M)	17	22	M17
GIKFR 18 PB	(SIKAC 18 M)	18	23	M18 x 1,5
GIKFR 20 PB	(SIKAC 20 M)	20	25	M20 x 1,5
GIKFR 22 PB	(SIKAC 22 M)	22	28	M22 x 1,5
GIKFR 25 PB	(SIKAC 25 M)	25	31	M24 x 2
GIKFR 28 PB	(SIKAC 28 M)	28	35	M27 x 2
GIKFR 30 PB	(SIKAC 30 M)	30	37	M30 x 2

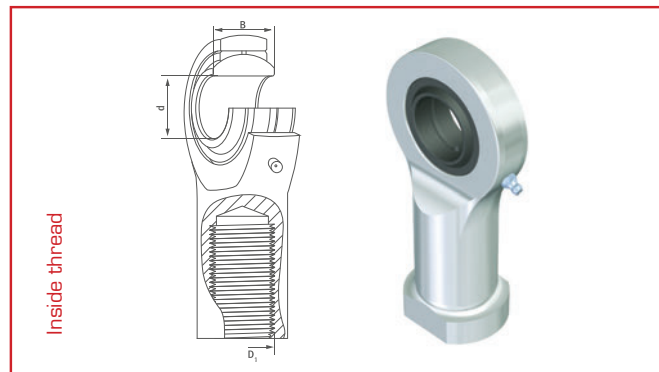

Rod end, steel / steel with inside thread

Art. Nr.		d	B	D ₁
GIR 6 DO	(SI 6 ES)	6	6	M6
GIR 8 DO	(SI 8 ES)	8	8	M8
GIR 10 DO	(SI 10 ES)	10	9	M10
GIR 12 DO	(SI 12 ES)	12	10	M12
GIR 15 DO	(SI 15 ES)	15	12	M14
GIR 17 DO	(SI 17 ES)	17	14	M16
GIR 20 DO	(SI 20 ES)	20	16	M20 x 1,5
GIR 25 DO	(SI 25 ES)	25	20	M24 x 2
GIR 30 DO	(SI 30 ES)	30	22	M30 x 2
GIR 35 DO	(SIA 35 ES)	35	25	M36 x 3
GIR 40 DO	(SIA 40 ES)	40	28	M39 x 3
GIR 45 DO	(SIA 45 ES)	45	32	M42 x 3
GIR 50 DO	(SIA 50 ES)	50	35	M45 x 3
GIR 60 DO	(SIA 60 ES)	60	44	M52 x 3
GIR 70 DO	(SIA 70 ES)	70	49	M56 x 4
GIR 80 DO	(SIA 80 ES)	80	55	M64 x 4

Permissible working temperature: -60°C - +150°C
(Applications up to +250°C with possible losses of length of life).
Further restrictions through lubricant should be kept in mind.

Permissible working temperature: -60°C - +150°C
(Applications up to +250°C with possible losses of length of life).
Further restrictions through lubricant should be kept in mind.

Rod ends

Requiring maintenance

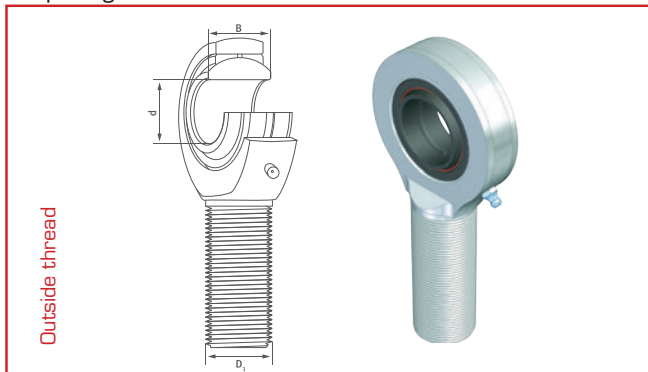

Rod end, steel / steel with outside thread and sealing

Art. Nr.		d	B	D ₁
GAR 15 DO 2RS	(SA 15 ES 2RS)	15	12	M14
GAR 17 DO 2RS	(SA 17 ES 2RS)	17	14	M16
GAR 20 DO 2RS	(SA 20 ES 2RS)	20	16	M20 x 1,5
GAR 25 DO 2RS	(SA 25 ES 2RS)	25	20	M24 x 2
GAR 30 DO 2RS	(SA 30 ES 2RS)	30	22	M30 x 2
GAR 35 DO 2RS	(SAA 35 ES 2RS)	35	25	M36 x 3
GAR 40 DO 2RS	(SAA 40 ES 2RS)	40	28	M39 x 3
GAR 45 DO 2RS	(SAA 45 ES 2RS)	45	32	M42 x 3
GAR 50 DO 2RS	(SAA 50 ES 2RS)	50	35	M45 x 3
GAR 60 DO 2RS	(SAA 60 ES 2RS)	60	44	M52 x 3
GAR 70 DO 2RS	(SAA 70 ES 2RS)	70	49	M56 x 4
GAR 80 DO 2RS	(SAA 80 ES 2RS)	80	55	M64 x 4

Rod ends

Maintenance-free

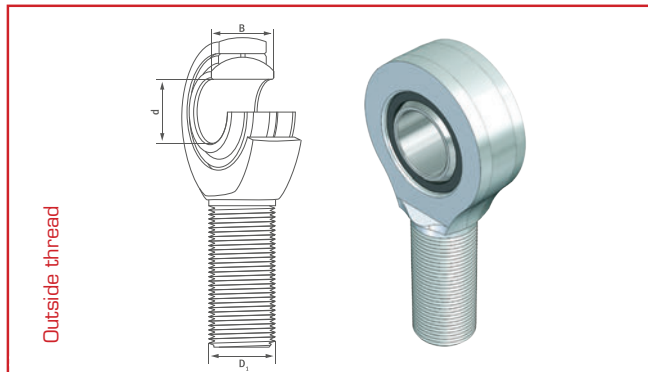

Rod end, steel / PTFE with outside thread

Art. Nr.		d	B	D ₁
GAKFR 5 PW	(SAKAC 5 F)	5	8	M5
GAKFR 6 PW	(SAKAC 6 F)	6	9	M6
GAKFR 8 PW	(SAKAC 8 F)	8	12	M8
GAKFR 10 PW	(SAKAC 10 F)	10	14	M10
GAKFR 12 PW	(SAKAC 12 F)	12	16	M12
GAKFR 14 PW	(SAKAC 14 F)	14	19	M14
GAKFR 16 PW	(SAKAC 16 F)	16	21	M16
GAKFR 17 PW	(SAKAC 17 F)	17	22	M17
GAKFR 18 PW	(SAKAC 18 F)	18	23	M18 x 1,5
GAKFR 20 PW	(SAKAC 20 F)	20	25	M20 x 1,5
GAKFR 22 PW	(SAKAC 22 F)	22	28	M22 x 1,5
GAKFR 25 PW	(SAKAC 25 F)	25	31	M24 x 2
GAKFR 28 PW	(SAKAC 28 F)	28	35	M27 x 2
GAKFR 30 PW	(SAKAC 30 F)	30	37	M30 x 2

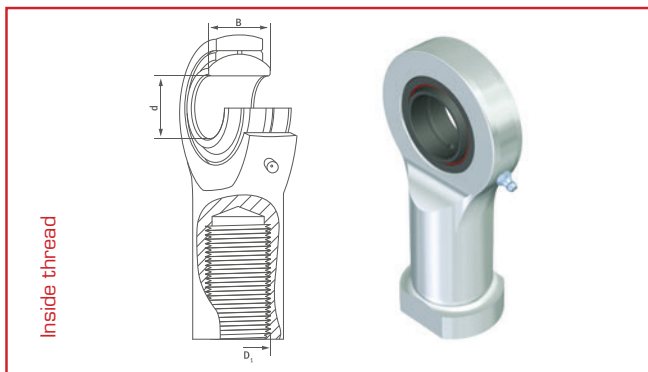

Rod end, steel / steel with inside thread and sealing

Art. Nr.		d	B	D ₁
GIR 15 DO 2RS	(SI 15 ES 2RS)	15	12	M14
GIR 17 DO 2RS	(SI 17 ES 2RS)	17	14	M16
GIR 20 DO 2RS	(SI 20 ES 2RS)	20	16	M20 x 1,5
GIR 25 DO 2RS	(SI 25 ES 2RS)	25	20	M24 x 2
GIR 30 DO 2RS	(SI 30 ES 2RS)	30	22	M30 x 2
GIR 35 DO 2RS	(SIA 35 ES 2RS)	35	25	M36 x 3
GIR 40 DO 2RS	(SIA 40 ES 2RS)	40	28	M39 x 3
GIR 45 DO 2RS	(SIA 45 ES 2RS)	45	32	M42 x 3
GIR 50 DO 2RS	(SIA 50 ES 2RS)	50	35	M45 x 3
GIR 60 DO 2RS	(SIA 60 ES 2RS)	60	44	M52 x 3
GIR 70 DO 2RS	(SIA 70 ES 2RS)	70	49	M56 x 4
GIR 80 DO 2RS	(SIA 80 ES 2RS)	80	55	M64 x 4

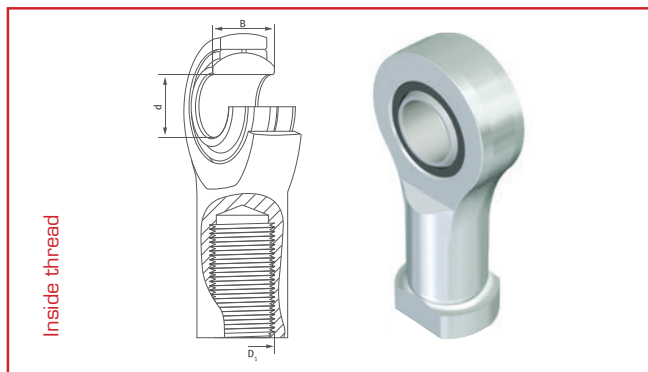

Rod end, steel / PTFE with inside thread

Art. Nr.		d	B	D ₁
GIKFR 5 PW	(SIKAC 5 F)	5	8	M5
GIKFR 6 PW	(SIKAC 6 F)	6	9	M6
GIKFR 8 PW	(SIKAC 8 F)	8	12	M8
GIKFR 10 PW	(SIKAC 10 F)	10	14	M10
GIKFR 12 PW	(SIKAC 12 F)	12	16	M12
GIKFR 14 PW	(SIKAC 14 F)	14	19	M14
GIKFR 16 PW	(SIKAC 16 F)	16	21	M16
GIKFR 17 PW	(SIKAC 17 F)	17	22	M17
GIKFR 18 PW	(SIKAC 18 F)	18	23	M18 x 1,5
GIKFR 20 PW	(SIKAC 20 F)	20	25	M20 x 1,5
GIKFR 22 PW	(SIKAC 22 F)	22	28	M22 x 1,5
GIKFR 25 PW	(SIKAC 25 F)	25	31	M24 x 2
GIKFR 28 PW	(SIKAC 28 F)	28	35	M27 x 2
GIKFR 30 PW	(SIKAC 30 F)	30	37	M30 x 2

Permissible working temperature: -60°C - +130°C (Applications up to +200°C without sealings and from 150°C with possible losses of length of life). Further restrictions through lubricant should be kept in mind.

Permissible working temperature: -60°C - +100°C (Applications up to +200°C with possible losses of length of life).

Rod ends Maintenance-free

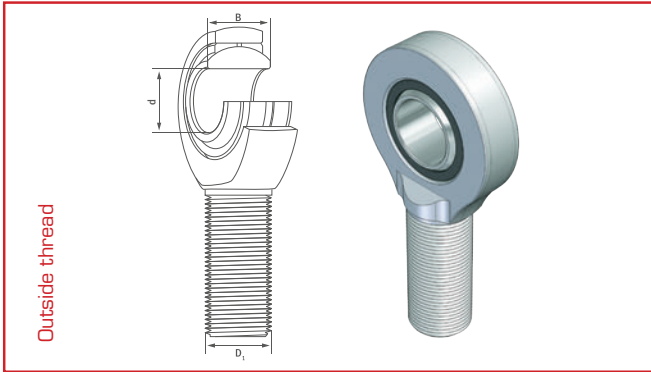

Rod end, hard chrome plated / PTFE with outside thread

Art. Nr.		d	B	D ₁
GAR 6 UK	(SA 6 C)	6	6	M6
GAR 8 UK	(SA 8 C)	8	8	M8
GAR 10 UK	(SA 10 C)	10	9	M10
GAR 12 UK	(SA 12 C)	12	10	M12
GAR 15 UK	(SA 15 C)	15	12	M14
GAR 17 UK	(SA 17 C)	17	14	M16
GAR 20 UK	(SA 20 C)	20	16	M20 x 1,5
GAR 25 UK	(SA 25 C)	25	20	M24 x 2
GAR 30 UK	(SA 30 C)	30	22	M30 x 2

Rod ends Maintenance-free

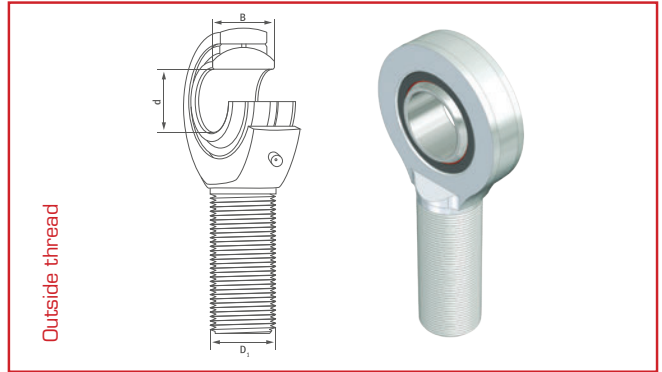

Rod end, hard chrome plated / PTFE with outside thread and sealing

Art. Nr.		d	B	D ₁
GAR 20 UK 2RS	(SA 20 TE 2RS)	20	16	M20 x 1,5
GAR 25 UK 2RS	(SA 25 TE 2RS)	25	20	M24 x 2
GAR 30 UK 2RS	(SA 30 TE 2RS)	30	22	M30 x 2
GAR 35 UK 2RS	(SAA 35 TE 2RS)	35	25	M36 x 3
GAR 40 UK 2RS	(SAA 40 TE 2RS)	40	28	M39 x 3
GAR 45 UK 2RS	(SAA 45 TE 2RS)	45	32	M42 x 3
GAR 50 UK 2RS	(SAA 50 TE 2RS)	50	35	M45 x 3
GAR 60 UK 2RS	(SAA 60 TE 2RS)	60	44	M52 x 3
GAR 70 UK 2RS	(SAA 70 TE 2RS)	70	49	M56 x 4
GAR 80 UK 2RS	(SAA 80 TE 2RS)	80	55	M64 x 4

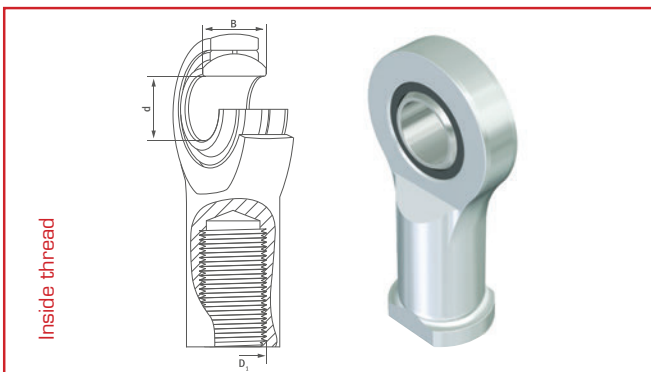

Rod end, hard chrome plated / PTFE with inside thread

Art. Nr.		d	B	D ₁
GIR 6 UK	(SI 6 C)	6	6	M6
GIR 8 UK	(SI 8 C)	8	8	M8
GIR 10 UK	(SI 10 C)	10	9	M10
GIR 12 UK	(SI 12 C)	12	10	M12
GIR 15 UK	(SI 15 C)	15	12	M14
GIR 17 UK	(SI 17 C)	17	14	M16
GIR 20 UK	(SI 20 C)	20	16	M20 x 1,5
GIR 25 UK	(SI 25 C)	25	20	M24 x 2
GIR 30 UK	(SI 30 C)	30	22	M30 x 2

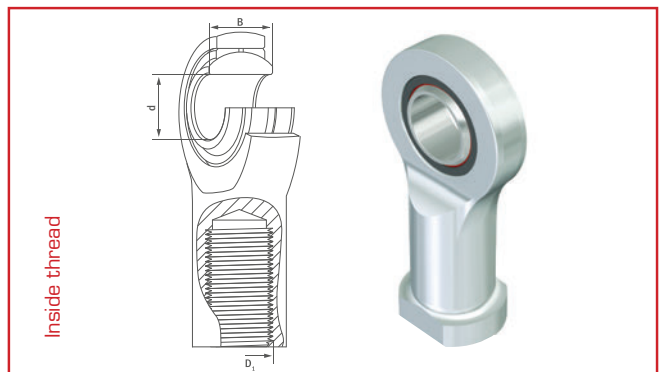

Rod end, hard chrome plated / PTFE with inside thread and sealing

Art. Nr.		d	B	D ₁
GIR 20 UK 2RS	(SA 20 TE 2RS)	20	16	M20 x 1,5
GIR 25 UK 2RS	(SA 25 TE 2RS)	25	20	M24 x 2
GIR 30 UK 2RS	(SA 30 TE 2RS)	30	22	M30 x 2
GIR 35 UK 2RS	(SAA 35 TE 2RS)	35	25	M36 x 3
GIR 40 UK 2RS	(SAA 40 TE 2RS)	40	28	M39 x 3
GIR 45 UK 2RS	(SAA 45 TE 2RS)	45	32	M42 x 3
GIR 50 UK 2RS	(SAA 50 TE 2RS)	50	35	M45 x 3
GIR 60 UK 2RS	(SAA 60 TE 2RS)	60	44	M52 x 3
GIR 70 UK 2RS	(SAA 70 TE 2RS)	70	49	M56 x 4
GIR 80 UK 2RS	(SAA 80 TE 2RS)	80	55	M64 x 4

Permissible working temperature: -60°C - +100°C
(Applications up to +200°C with possible losses of length of life).

Permissible working temperature: -60°C - +100°C
(Applications up to +200°C with possible losses of length of life).

Hydraulic rod ends

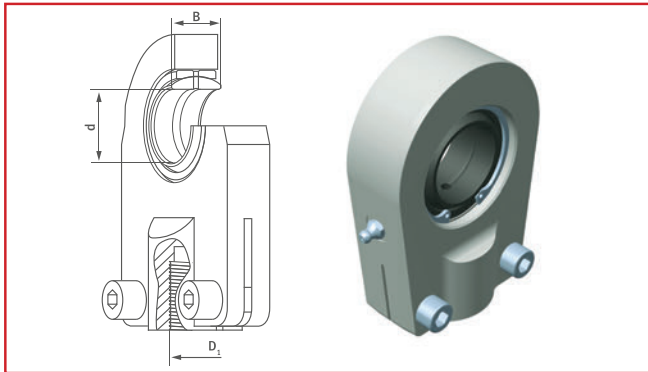

Hydraulic rod end, steel / steel with inside thread clampable

Art. Nr.		d	B	D ₁
GIHR-K 20 DO	(SIR 20 ES)	20	16	M16 x 1,5
GIHR-K 25 DO	(SIR 25 ES)	25	20	M16 x 1,5
GIHR-K 30 DO	(SIR 30 ES)	30	22	M22 x 1,5
GIHR-K 35 DO	(SIR 35 ES)	35	25	M28 x 1,5
GIHR-K 40 DO	(SIR 40 ES)	40	28	M35 x 1,5
GIHR-K 50 DO	(SIR 50 ES)	50	35	M45 x 1,5
GIHR-K 60 DO	(SIR 60 ES)	60	44	M58 x 1,5
GIHR-K 70 DO	(SIR 70 ES)	70	49	M65 x 1,5
GIHR-K 80 DO	(SIR 80 ES)	80	55	M80 x 2
GIHR-K 90 DO	(SIR 90 ES)	90	60	M100 x 2
GIHR-K 100 DO	(SIR 100 ES)	100	70	M110 x 2
GIHR-K 110 DO	(SIR 110 ES)	110	70	M120 x 2
GIHR-K 120 DO	(SIR 120 ES)	120	85	M130 x 2

Hydraulic rod ends

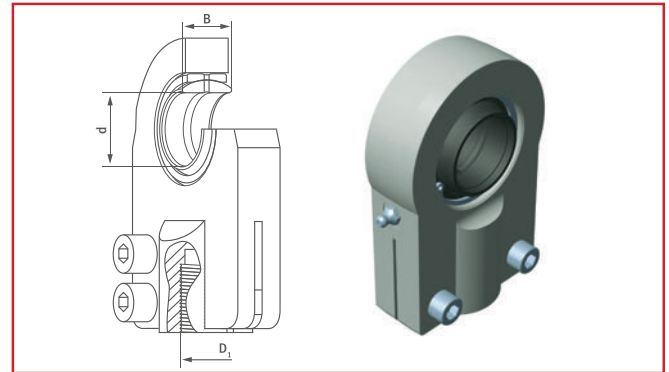

Hydraulic rod end, steel / steel with inside thread clampable

Art. Nr.		d	B	D ₁
GIHN-K 12 LO	(SIGG 12 ES)	12	12	M12 x 1,25
GIHN-K 16 LO	(SIGG 16 ES)	16	16	M14 x 1,5
GIHN-K 20 LO	(SIGG 20 ES)	20	20	M16 x 1,5
GIHN-K 25 LO	(SIGG 25 ES)	25	25	M20 x 1,5
GIHN-K 32 LO	(SIGG 32 ES)	32	32	M27 x 2
GIHN-K 40 LO	(SIGG 40 ES)	40	40	M33 x 2
GIHN-K 50 LO	(SIGG 50 ES)	50	50	M42 x 2
GIHN-K 63 LO	(SIGG 63 ES)	63	63	M48 x 2
GIHN-K 70 LO	(SIGG 70 ES)	70	70	M56 x 2
GIHN-K 80 LO	(SIGG 80 ES)	80	80	M64 x 2
GIHN-K 90 LO	(SIGG 90 ES)	90	90	M72 x 3
GIHN-K 100 LO	(SIGG 100 ES)	100	100	M80 x 3
GIHN-K 110 LO	(SIGG 110 ES)	110	110	M90 x 3
GIHN-K 125 LO	(SIGG 125 ES)	125	125	M100 x 3
GIHN-K 160 LO	(SIGG 160 ES)	160	160	M125x4
GIHN-K 200 LO	(SIGG 200 ES)	200	200	M160x4

Hydraulic rod end, steel / steel with inside thread non-clampable

Art. Nr.		d	B	D ₁
GIHR 20 DO	(SIRD 20 ES)	20	16	M16 x 1,5
GIHR 25 DO	(SIRD 25 ES)	25	20	M16 x 1,5
GIHR 30 DO	(SIRD 30 ES)	30	22	M22 x 1,5
GIHR 35 DO	(SIRD 35 ES)	35	25	M28 x 1,5
GIHR 40 DO	(SIRD 40 ES)	40	28	M35 x 1,5
GIHR 50 DO	(SIRD 50 ES)	50	35	M45 x 1,5
GIHR 60 DO	(SIRD 60 ES)	60	44	M58 x 1,5
GIHR 70 DO	(SIRD 70 ES)	70	49	M65 x 1,5
GIHR 80 DO	(SIRD 80 ES)	80	55	M80 x 2
GIHR 90 DO	(SIRD 90 ES)	90	60	M100 x 2
GIHR 100 DO	(SIRD 100 ES)	100	70	M110 x 2
GIHR 110 DO	(SIRD 110 ES)	110	70	M120 x 3
GIHR 120 DO	(SIRD 120 ES)	120	85	M130 x 3

Hydraulic rod end, steel / steel with inside thread clampable

Art. Nr.		d	B	D ₁
GIHO-K 12 DO	(SIJ 12 ES)	12	10	M10 x 1,25
GIHO-K 16 DO	(SIJ 16 ES)	16	14	M12 x 1,25
GIHO-K 20 DO	(SIJ 20 ES)	20	16	M14 x 1,5
GIHO-K 25 DO	(SIJ 25 ES)	25	20	M16 x 1,5
GIHO-K 30 DO	(SIJ 30 ES)	30	22	M20 x 1,5
GIHO-K 40 DO	(SIJ 40 ES)	40	28	M27 x 2
GIHO-K 50 DO	(SIJ 50 ES)	50	35	M33 x 2
GIHO-K 60 DO	(SIJ 60 ES)	60	44	M42 x 2
GIHO-K 80 DO	(SIJ 80 ES)	80	55	M48 x 2
GIHO-K 100 DO	(SIJ 100 ES)	100	70	M64 x 3

Permissible working temperature: -60°C - +150°C
 (Applications up to +250°C with possible losses of length of life).
 Further restrictions through lubricant should be kept in mind.

Permissible working temperature: -60°C - +150°C
 (Applications up to +250°C with possible losses of length of life).
 Further restrictions through lubricant should be kept in mind.

Hydraulic rod ends

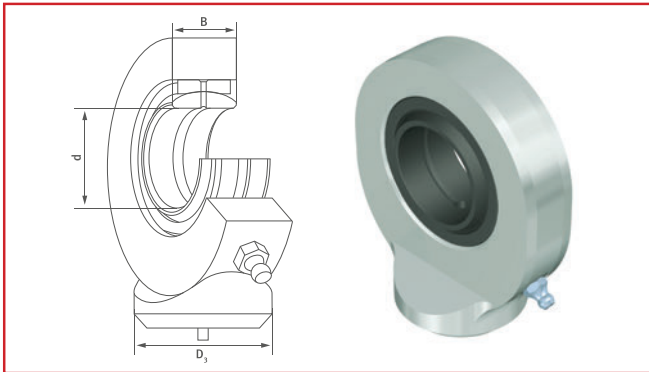

Hydraulic rod end, steel / steel with round weld-on bolt

Art. Nr.		d	B	D ₃
GK 10 DO	(SC 10 ES)	10	9	15,0
GK 12 DO	(SC 12 ES)	12	10	17,5
GK 15 DO	(SC 15 ES)	15	12	21,0
GK 17 DO	(SC 17 ES)	17	14	24,0
GK 20 DO	(SC 20 ES)	20	16	27,5
GK 25 DO	(SC 25 ES)	25	20	33,5
GK 30 DO	(SC 30 ES)	30	22	40,0
GK 35 DO	(SC 35 ES)	35	25	47,0
GK 40 DO	(SC 40 ES)	40	28	52,0
GK 45 DO	(SC 45 ES)	45	32	58,0
GK 50 DO	(SC 50 ES)	50	35	62,0
GK 60 DO	(SC 60 ES)	60	44	70,0
GK 70 DO	(SC 70 ES)	70	49	80,0
GK 80 DO	(SC 80 ES)	80	55	95,0

Hydraulic rod ends

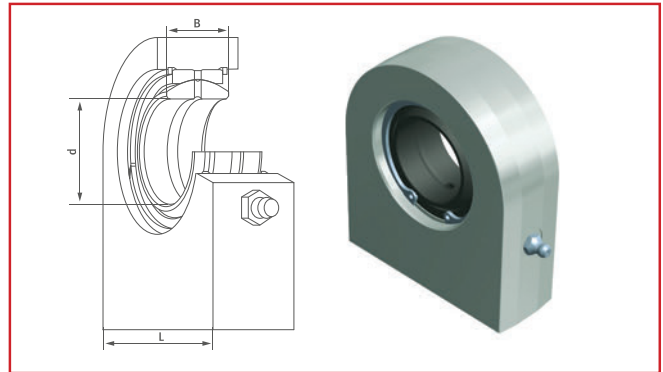

Hydraulic rod end, steel / steel with angular weld-on bolt

Art. Nr.		d	B	L
GF 20 DO	(SCF 20 ES)	20	16	50
GF 25 DO	(SCF 25 ES)	25	20	55
GF 30 DO	(SCF 30 ES)	30	22	65
GF 35 DO	(SCF 35 ES)	35	25	83
GF 40 DO	(SCF 40 ES)	40	28	100
GF 45 DO	(SCF 45 ES)	45	32	110
GF 50 DO	(SCF 50 ES)	50	35	123
GF 60 DO	(SCF 60 ES)	60	44	140
GF 70 DO	(SCF 70 ES)	70	49	164
GF 80 DO	(SCF 80 ES)	80	55	180
GF 90 DO	(SCF 90 ES)	90	60	226
GF 100 DO	(SCF 100 ES)	100	70	250
GF 110 DO	(SCF 110 ES)	110	70	295
GF 120 DO	(SCF 120 ES)	120	85	360

Permissible working temperature: -60°C - +150°C
(Applications up to +250°C with possible losses of length of life).
Further restrictions through lubricant should be kept in mind.

Permissible working temperature: -60°C - +150°C
(Applications up to +250°C with possible losses of length of life).
Further restrictions through lubricant should be kept in mind.



Quality Management System Certificate of Approval

This is to certify that the QMS of
SBS-SINGA BEARINGS SOLUTIONS PTE LTD

50 Bukit Batok Street 23
#06-08 Midview Building
Singapore 659578

Has been assessed and found to meet the requirements of

ISO 9001:2015

This certificate is valid for the following scope of operations:

Trading of Sliding Bearings including Technical Support

Authorised by 

Ye Rouyan
Director

Date of Certificate Issue: 29 August 2019

Certificate Valid Until: 28 August 2022

Certified since 29 August 2016.

This certificate is the property of DAS Certification and remains valid subject to satisfactory annual surveillance audits.

DAS Certification Singapore Pte Ltd

33 Ubi Avenue 3
#02-34 Vertex Tower A
Singapore 408868
Tel: (65) 6333 5023
Email: info@dascertsg.com
Web: www.dascertsg.com
Company number: 200720506W

Certificate Number: 40454



Some of our other projects:

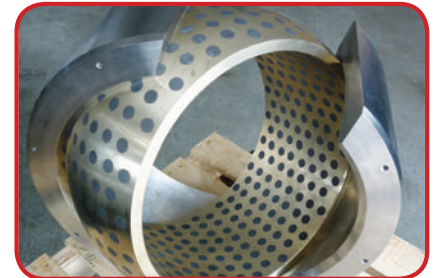
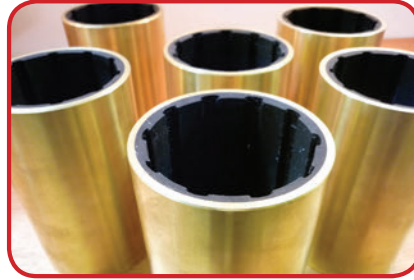
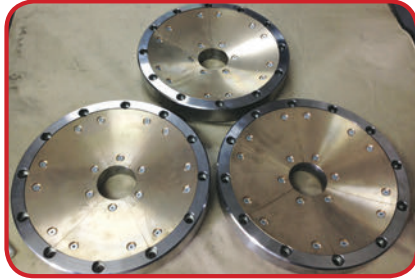
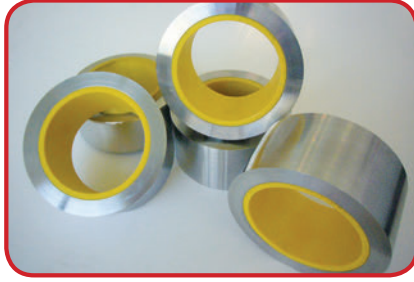

We are looking forward to hear from you!



SBS - Singa Bearings Solutions[®] PTE. LTD.

50 Bukit Batok St. 23

#06-08 Midview Bldg.

Singapore 659578

Tel.: +65 6316 3850

Fax: +65 6316 3851

www.sbs-bearings.com

info@sbs-bearings.com.sg